

SEIKO

DIGITAL QUARTZ

Cal. A156A

PARTS LIST

Cal. A156A

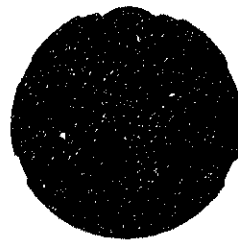

4001 866

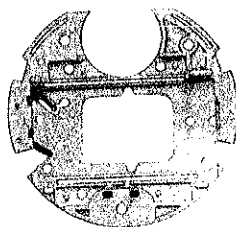

4033 866



4245 860



4313 860



☆4510 830

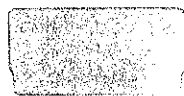

4521 550
4521 551



4540 860



4580 860



☆WSR265H

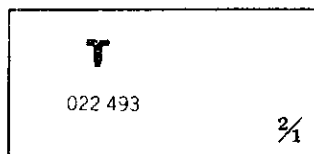

Cal. A156A

Characteristics

Casing diameter: ϕ 30.1 mm
 Maximum height: 6.5 mm without battery
 Frequency of quartz crystal oscillator: 32,768 Hz (Hz=Hertz Cycle per second)
 Time display: Digital Display System showing hour, minute, second and day of the week.
 Calendar display: Digital Display System showing month, date and day of the week and "A" (AM)/"P" (PM).
 Alarm display: Can be set to operate at any desired hour and minute.
 Stopwatch display: 1/2-hour Digital Display System showing hour, minute and second (or minute, second and 1/10 second up to 20 minutes measurement)
 Display medium: Nematic Liquid Crystal system, FE-Mode
 Time micro adjuster: Trimmer condenser system
 Illuminating light: Illuminates all the digital displays in the dark by depressing the light button.
 Battery recharge indicator: All the digits in the display begin flashing.
 Battery power: Primary battery Silicone solar cell
 Secondary battery Silver oxide battery

PART NO.	PART NAME	PART NO.	PART NAME
4001 866	Circuit block		
4033 866	Frame for liquid crystal panel (with bulb)		
4245 860	Switch spring		
4313 860	Connector		
☆4510 830	Liquid crystal panel		
4521 550	Reflecting mirror (Silver)		
4521 551	Reflecting mirror (Gold)		
4540 860	Liquid crystal panel holder		
4580 860	Speaker block		
022 493	Liquid crystal panel holder screw		
☆WSR265H	Silver oxide battery (Secondary battery)		

Remarks:

Liquid crystal panel

Be sure that the combination between the color of panel cover and liquid crystal panel should be matched according to the "SEIKO Quartz Casing Parts List".

Battery

☆WSR265H.....This battery is specially produced as the secondary Battery for the silicon solar cell. Be sure to use the battery WSR265H when replacing the battery with a new one.

TECHNICAL GUIDE

SEIKO

DIGITAL QUARTZ

CAL. A156A

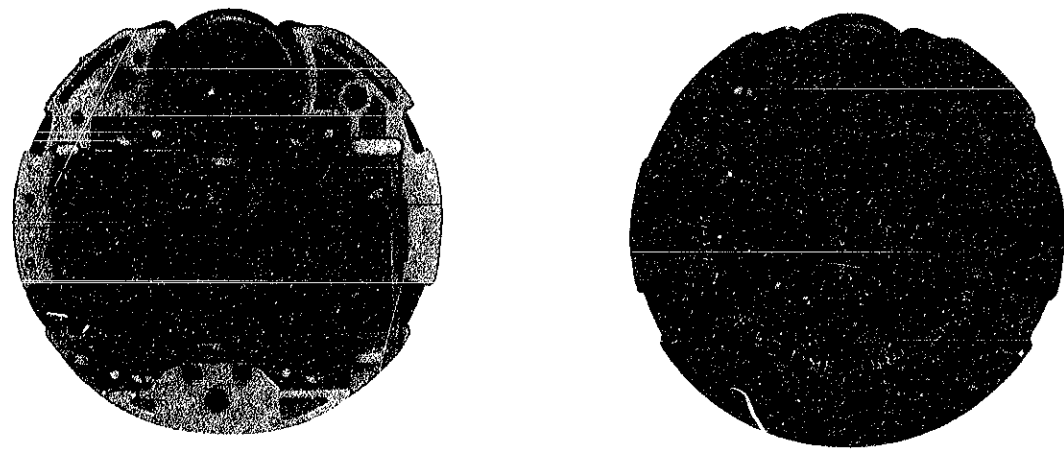

CONTENTS

I. SPECIFICATIONS	1
II. DISASSEMBLING, REASSEMBLING AND LUBRICATING	2
1. Disassembling, reassembling and lubricating of the case	2
2. Disassembling and reassembling of the module	6
III. CHECKING AND ADJUSTMENT	9
1. Guide table for checking and adjustment	9
2. Relationship between the segment (Liquid Crystal Panel Electrode) and the C-MOS-LSI output terminal	10
3. Procedures for checking and adjustment	11
A : Check battery recharging	11
B : Check secondary battery voltage	11
• How to check battery electrolyte leakage and repair	12
• Check pattern segment checking system	13
C : Check contact of C-MOS-LSI ~ liquid crystal panel	13
D : Check liquid crystal panel and circuit block	14
E : Check solar battery	15
F : Check current consumption	17
G : Check accuracy	17
H : Check functioning and adjustment	18
I : Check speaker block	18
J : Check bulb condition	20
K : Check conductivity of switch components	21

Calibre A156A

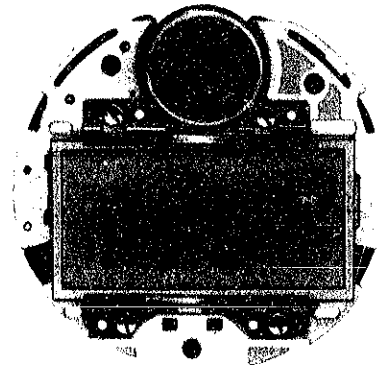

Module

I. SPECIFICATIONS

Item	Calibre No. A156A
Display medium	Nematic Liquid Crystal, FEM (Field Effect Mode)
Display system	<p>Four-function changeover system with time, stopwatch, alarm setting and time/calendar setting functions</p> <ul style="list-style-type: none"> Time function: Digital display system showing hour, minute, second and day of the week. In the time function, calendar and time set for the alarm are displayed by depressing a button. <ul style="list-style-type: none"> Calendar: Digital display showing month, date, day of the week and "A" (for AM)/"P" (for PM) Time set for the alarm: Digital display system showing hour, minute and "A" (for AM)/"P" (for PM) Stopwatch function: 12-hour digital display system showing hour, minute, second and 1/10 second (The 1/10 second measurement is possible up to 20 minutes.) Alarm setting function: Alarm time can be set to operate at the desired minute and 12-hour (with "A" (for AM)/"P" (for PM) indication). Time/calendar setting function: Setting of the second, minute, hour ("A" (for AM)/"P" (for PM)), date, month and day of the week.
Additional mechanism	<ul style="list-style-type: none"> Alarm test system Battery recharge indicator (The entire display starts flashing when the secondary battery needs to be recharged.) Time signal starts sounding every hour on the hour. (When the minute digits and the second digits indicate "00".) Sounding device for confirmation of stopwatch operation Illuminating light Pattern segment light-up system
Crystal oscillator	32,768 Hz (Hz = Hertz . . . Cycle per second)
Loss/gain	Loss/gain at normal temperature range Mean monthly rate: less than 10 seconds
Casing diameter	φ30.1mm
Height	6.5mm without battery
Operational temperature range	-10°C ~ +60°C (14°F ~ 140°F)
Regulation system	Trimmer condenser
Battery power	<p>Primary battery : Silicone solar cell Secondary battery : Silver oxide battery (WSR265H)</p> <ul style="list-style-type: none"> This battery is specially produced as the secondary battery for the silicon solar cell. Be sure to use the battery WSR265H when replacing the battery with a new one. Secondary battery life is approximately 10 years.
IC (Integrated Circuit)	C-MOS-LSI 1 piece LIMITER IC 1 piece

SEIKO LC Digital Quartz Alarm Chronograph Cal. A156 is a revolutionary multifunctional digital watch which incorporates a solar battery into the Cal. A158. The solar battery eliminates the need for battery replacement. The electronic circuit and the secondary battery are so fabricated that they prevent the battery from being over-charged and bursting.

* For the structure and the working principles of the solar battery, refer to the TECHNICAL GUIDE of Cal. 4826A and the SEIKO QUARTZ WATCH ADVANCED TECHNICAL THEORY (SUPPLEMENT II).

II. DISASSEMBLING, REASSEMBLING AND LUBRICATING

1. Disassembling, reassembling and lubricating of the case

Disassembling procedures Figs.: ① ~ ⑤

Reassembling procedures Figs.: ⑤ ~ ①

Lubricating: Silicone grease (500,000 c.s.), normal quantity

ex) A156-5009 A2

Glass and speaker portions

It is not necessary to disassemble the glass and the speaker cover except when they are required to be replaced.
(Refer to pages 4 and 5 for handling them.)

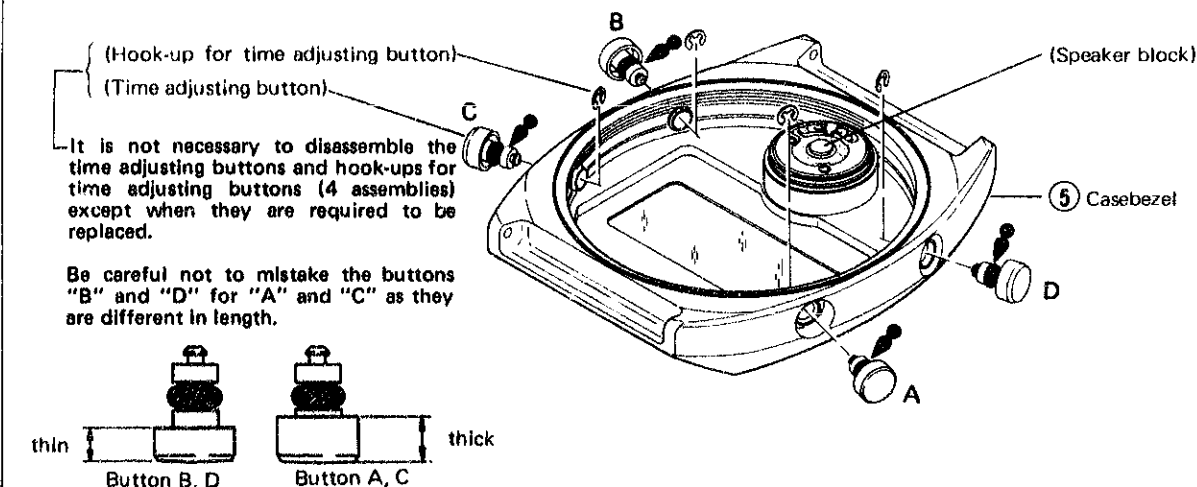
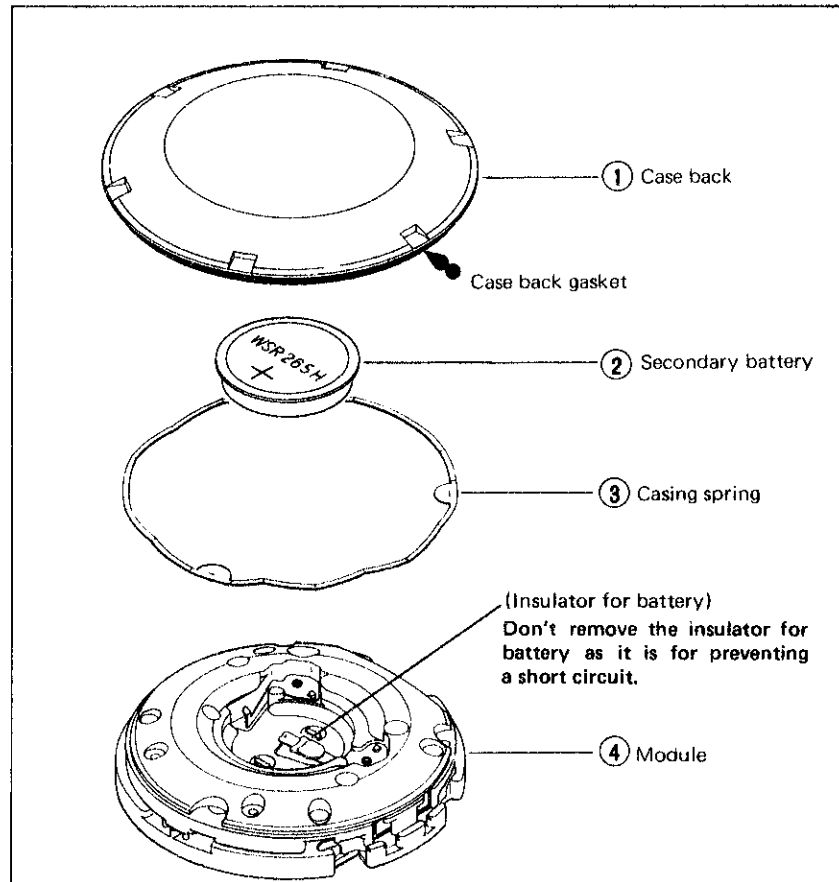
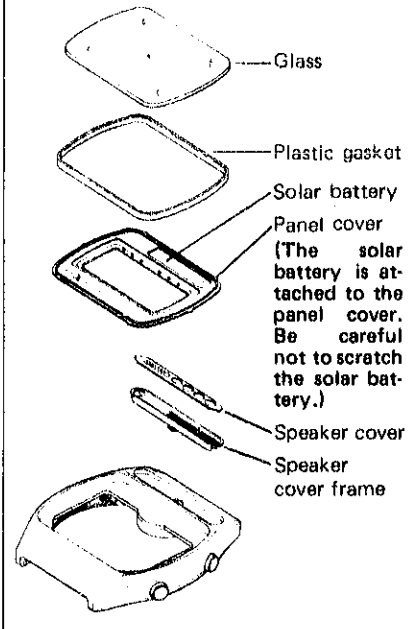

Remarks for disassembling

- ④ **Module**
 - The liquid crystal panel frame is fixed firmly to the casebezel. Pry up the module with tweezers to take out.
(Do not pry up at the speaker portion; the terminals of the speaker coil may be broken.)
- ⑤ **Casebezel**
 - The speaker block is set in the casebezel.
(Refer to page 7 for disassembling procedures.)

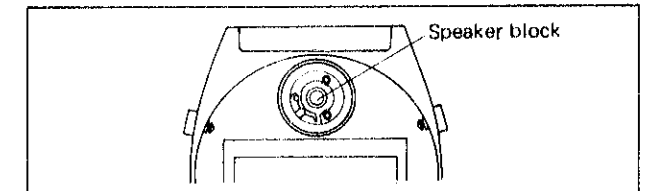
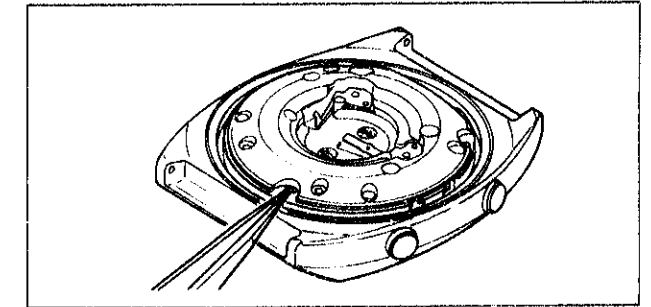

Remarks for reassembling

- ⑤ **Casebezel**
 - Before reassembling the module, pull out all buttons so that the switch springs do not prevent the module from being reassembled. (Push the buttons from inside with tweezers.)
- ④ **Module**
 - The liquid crystal panel frame is fixed firmly to the casebezel. Push in the module with fingers.
 - Push it in so that it does not catch the buttons.

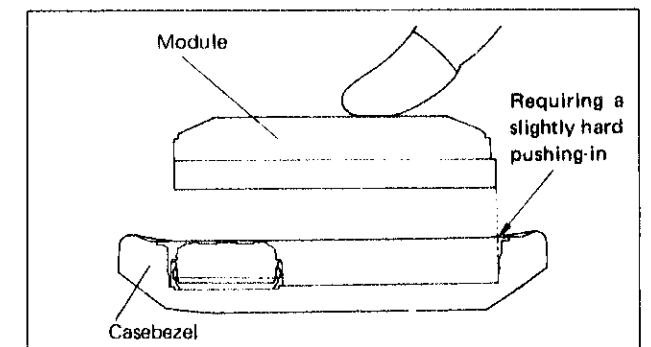
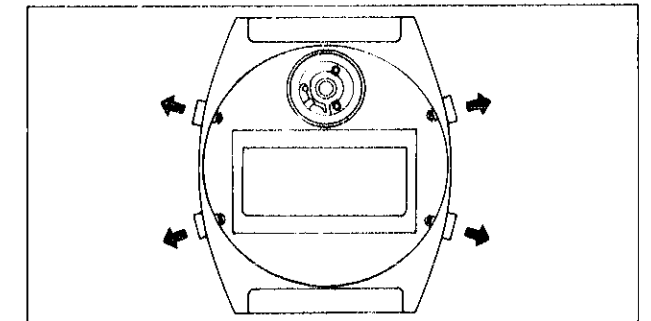

- ③ **Casing spring**
 - Set the casing spring. Be careful not to mistake front for back.
(The casing spring has three protrusions, two of which are larger and one which is smaller. Be sure to fit each of them to the corresponding notches of the module.)

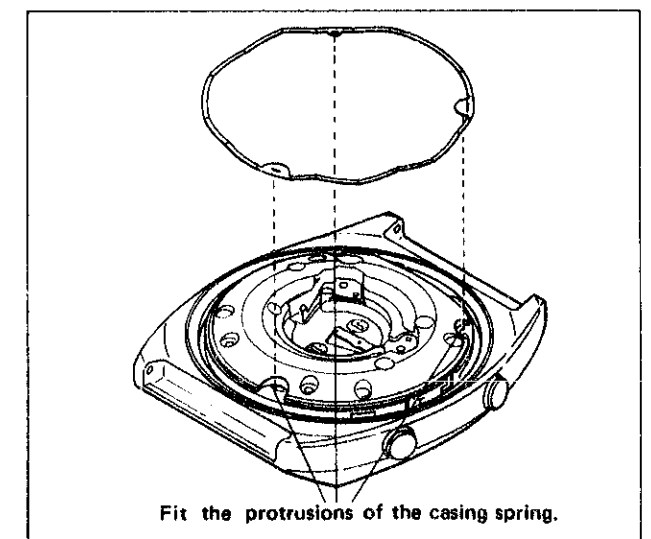

How to replace the glass

It is not necessary to replace the glass except when the panel cover (with the solar battery) is required to be replaced.

• Disassembling of the glass

- Use the tightening tool S-220 to disassemble the glass.
Inserting disk : S-162
Supporting disk : Inside diameter is in the neighborhood of 34.0mm
- Place a vinyl sheet between the glass and the supporting disk as shown in the illustration.
- With the inserting disk (S-162), push only the glass for disassembling.
(Do not push the panel cover as the solar battery might be damaged.)

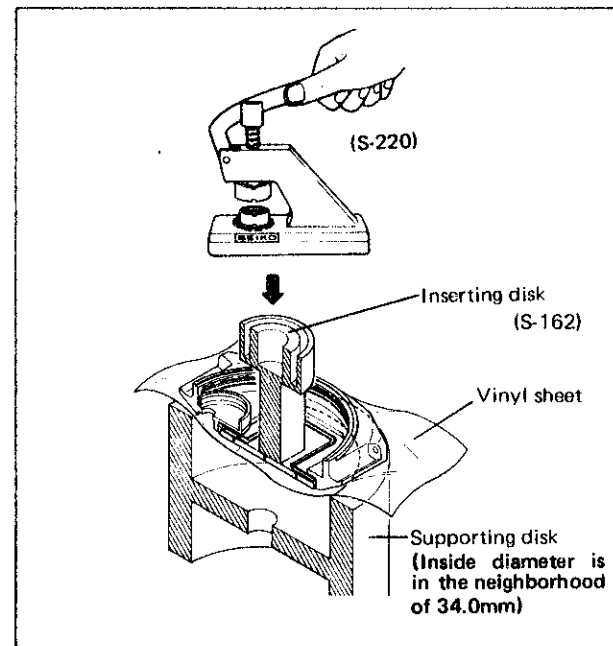

• Reassembling of the glass

- Reassemble the panel cover.
 - Be sure to set the backside of the panel cover fast to the casebezel.
 - Be sure that the space between the casebezel and the edge of the panel cover is uniform in width.
 - Be careful not to damage the solar battery.
- Set the plastic gasket.
 - Be sure to replace the plastic gasket with a new one.
 - Be careful not to mistake the upper side for the lower side. (Set in the arrow-marked direction.)
- Place the glass.
 - Be careful not to mistake the upper side for the lower side.
- Push in the glass (by using S-220)
 - Inserting disk : Plastic supporting disk (S-173)
 - Supporting disk : Inside diameter is in the neighborhood of 28.0mm~28.5mm

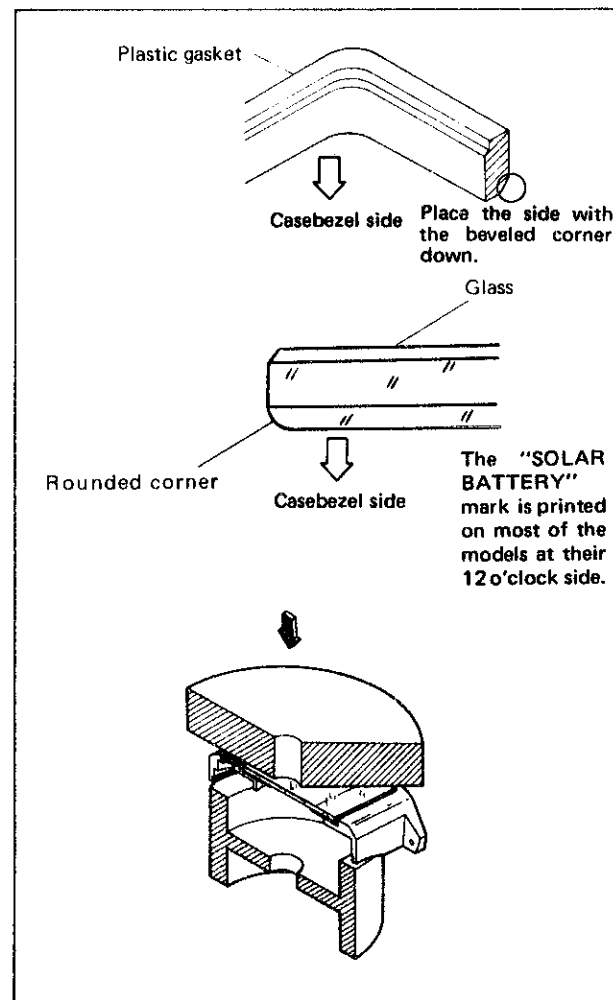

How to replace the speaker cover

The speaker cover and the speaker cover frame are set to the casebezel. It is not necessary to disassemble the speaker cover and the speaker cover frame except when they are required to be replaced.

• How to disassemble the speaker cover

- Disassemble the speaker.
(Refer to page 7 for the disassembling procedures of the speaker.)
- Disassemble the speaker cover by pushing it through the speaker hole inside the casebezel. The speaker cover and the speaker cover frame are removed together. (Fig. 1)
- Remove the speaker cover as shown in Fig. 2. Remove the speaker cover in the order of ①, ② and ③ as shown in Fig. 2.

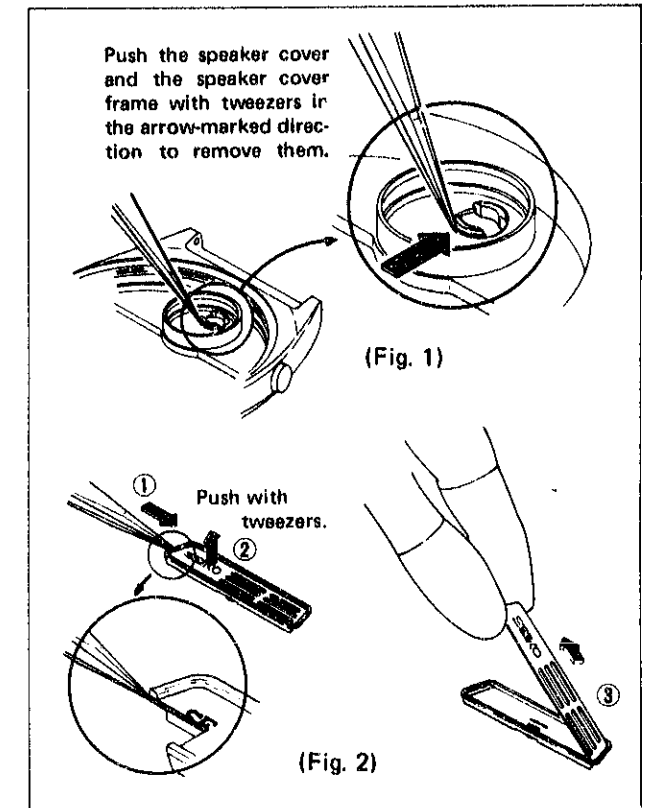

• How to reassemble the speaker cover

- Set the speaker cover to the speaker cover frame in reverse order to the disassembling procedures. (Fig. 3)
The dust protective sheet can be reused, if not damaged.
- Set the speaker cover and the speaker cover frame to the casebezel. Fit the leg portion of the speaker cover to the speaker hole portion of the casebezel and push it in. (Fig. 4)
If the speaker cover cannot be pushed in with fingers, place a vinyl sheet on it so as not to scratch and push it hard with the flat part of the end of the tweezers.

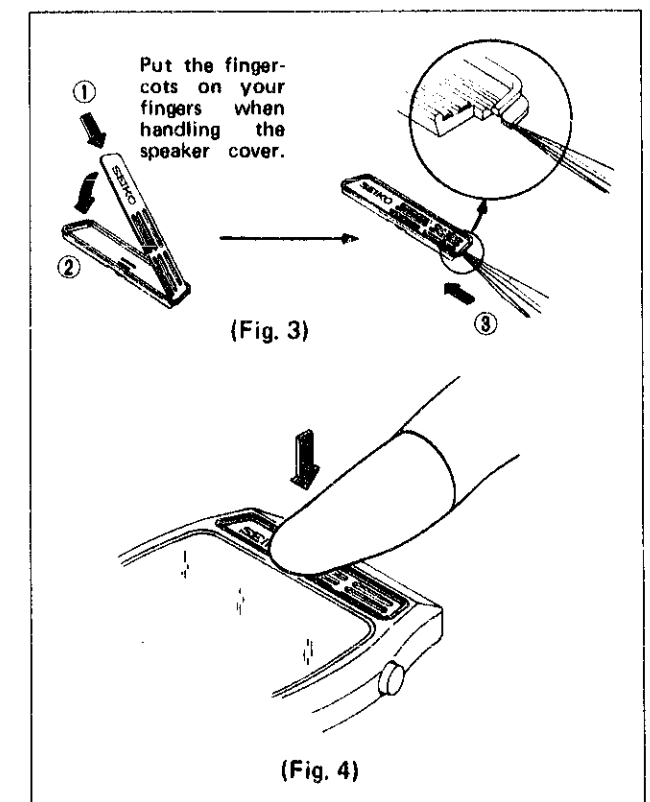

2. Disassembling and reassembling of the module

Disassembling procedures Figs. : ① ~ ⑨

Reassembling procedures Figs. : ⑨ ~ ①

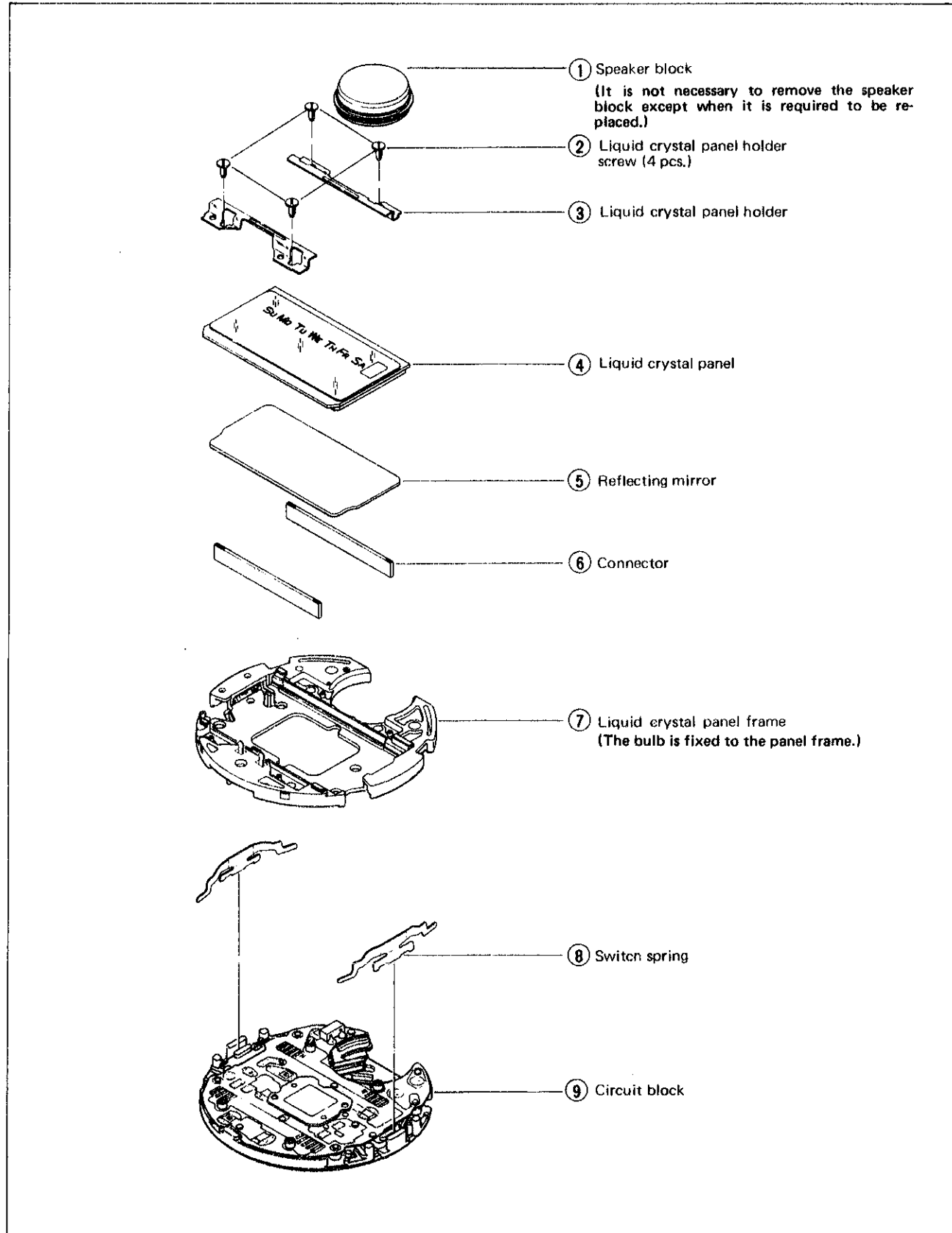

Remarks for disassembling

- ① **Speaker block**
- Hold the speaker block at its groove by the tips of the tweezers and pull out the speaker block from the case bezel as shown in the illustration.
 - Or pry out the speaker block by pushing up on its outer edge evenly with the tip of a screwdriver.

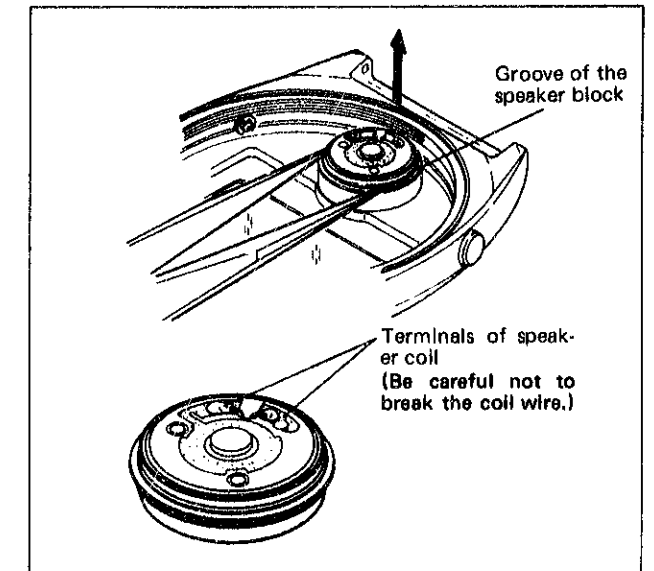
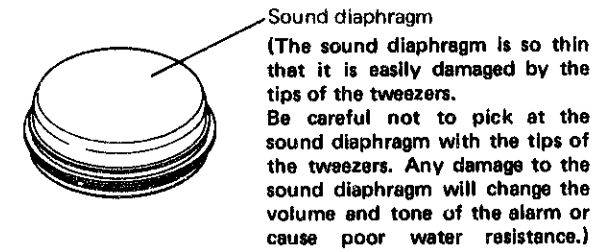

- When the speaker gasket is replaced, be careful not to mistake the upper side for the lower side. (Reassemble the speaker gasket with its round side turned up. Otherwise, the speaker gasket may be twisted.)

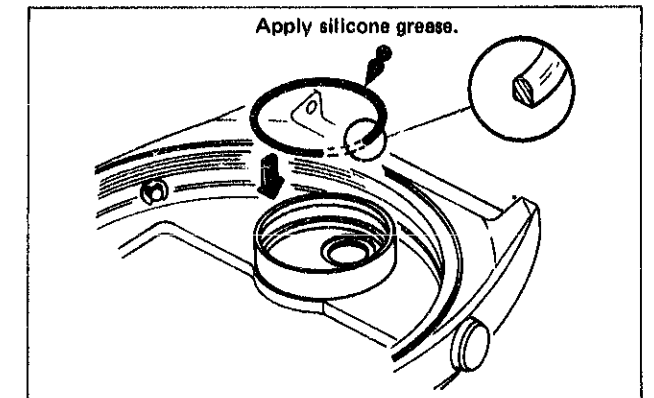

- ⑤ **Reflecting mirror**
- Be careful not to scratch or contaminate the reflecting mirror.
- ⑥ **Connector**
- The connectors may be disassembled together with the liquid crystal panel.
 - Be careful not to scratch the connectors with tweezers.
 - There is no difference between the top and bottom of the connectors.
- ⑨ **Circuit block**
- Be careful not to touch the electronic parts except when it is required.

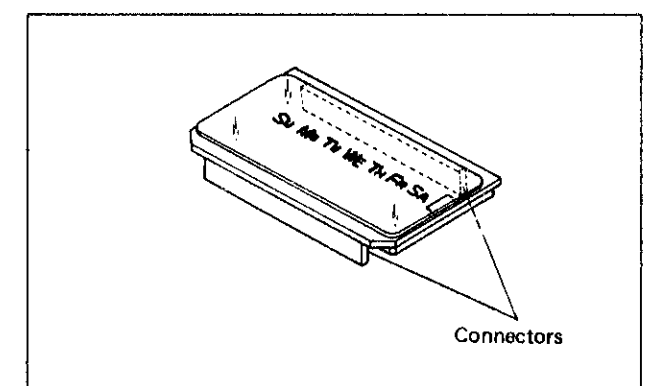

Remarks for reassembling

- ⑧ **Switch spring**
- Set the switch spring in position vertically from above.
 - Push in by the flat part of the end of the tweezers.

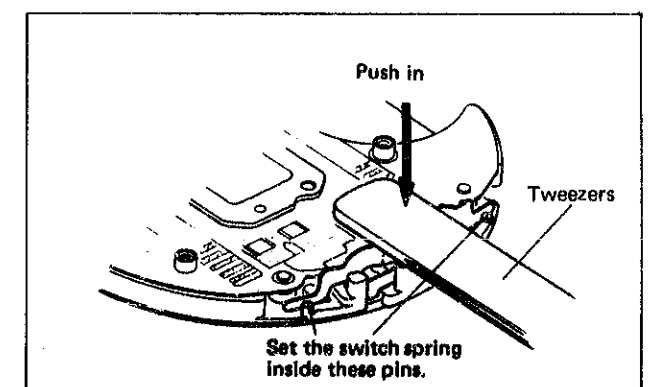

1. Guide table for checking and adjustment

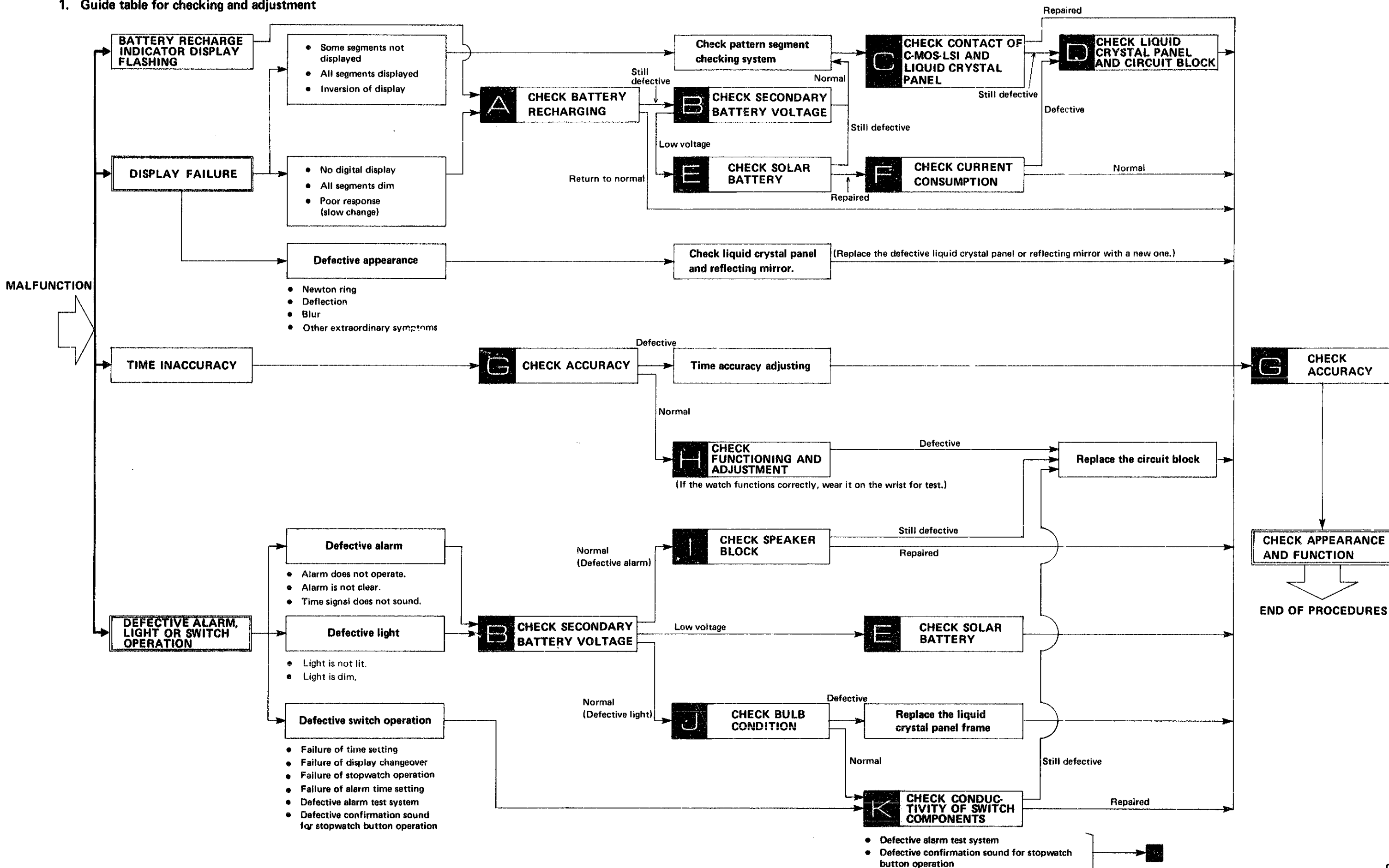

2. Relationship between the segment (Liquid Crystal Panel Electrode) and the C-MOS-LSI output terminal

A complete knowledge of how the segment (Liquid Crystal Panel Electrode) works with the C-MOS-LSI output terminal will provide the proper procedures for checking and adjustment.

• Designation of segment

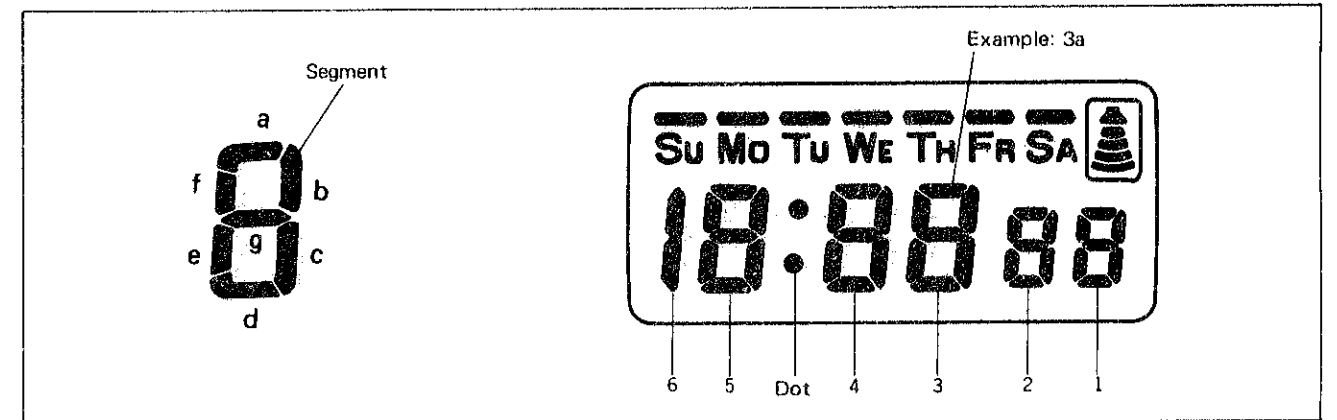

• Relationship between the segment and the C-MOS-LSI output terminal

The liquid crystal panel electrode is connected electrically with each segment which forms a digital figures as shown in the illustration of the panel pattern below. (The panel pattern can be seen if the panel is slightly tilted and looked at in an angular position.)

Also, the liquid crystal panel electrode is connected electrically with the C-MOS-LSI output terminal by the connector.

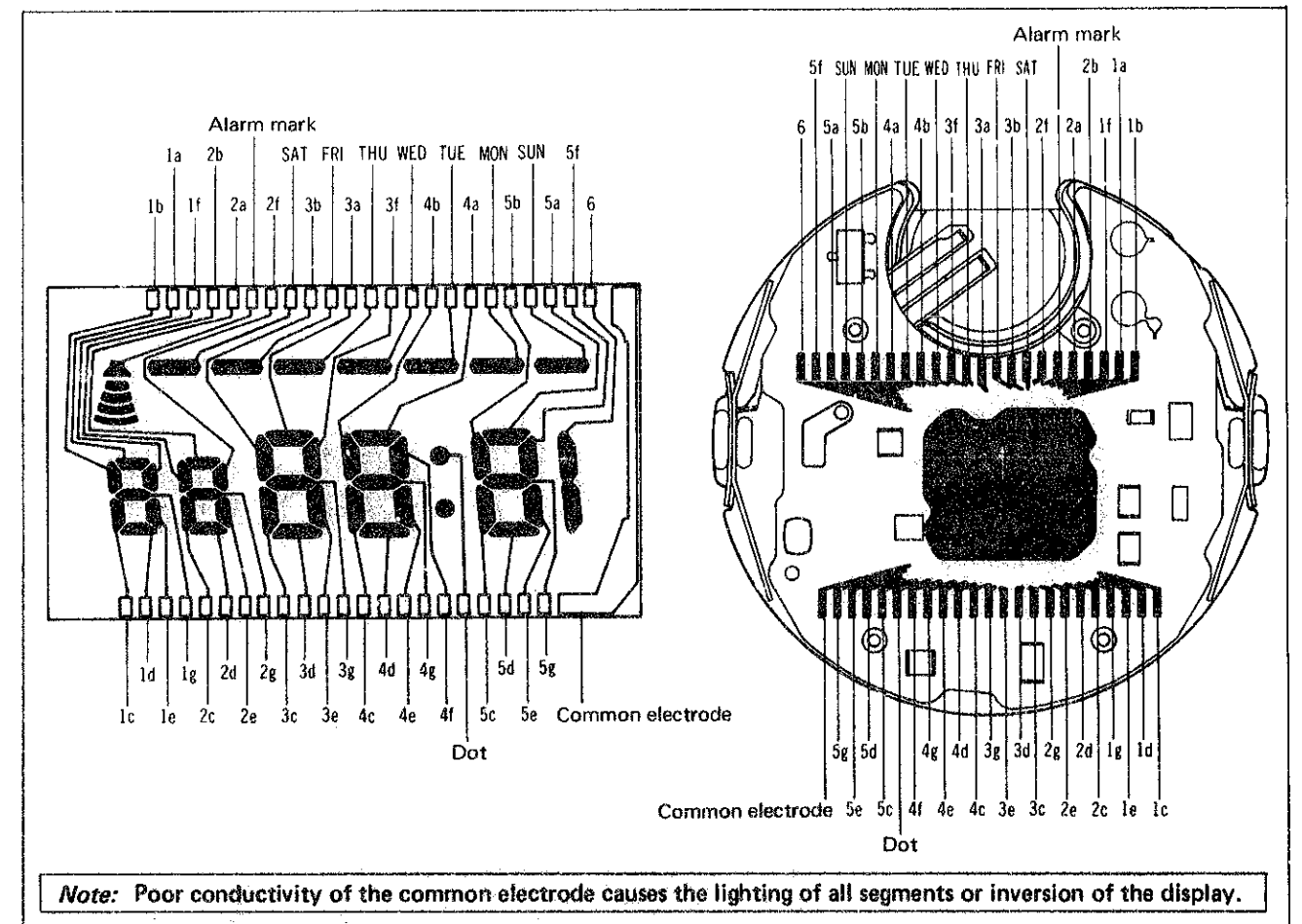

III. CHECKING AND ADJUSTMENT

Be sure to use the Static Electricity Protector (ES 830) when handling the module.

1. Guide table for checking and adjustment

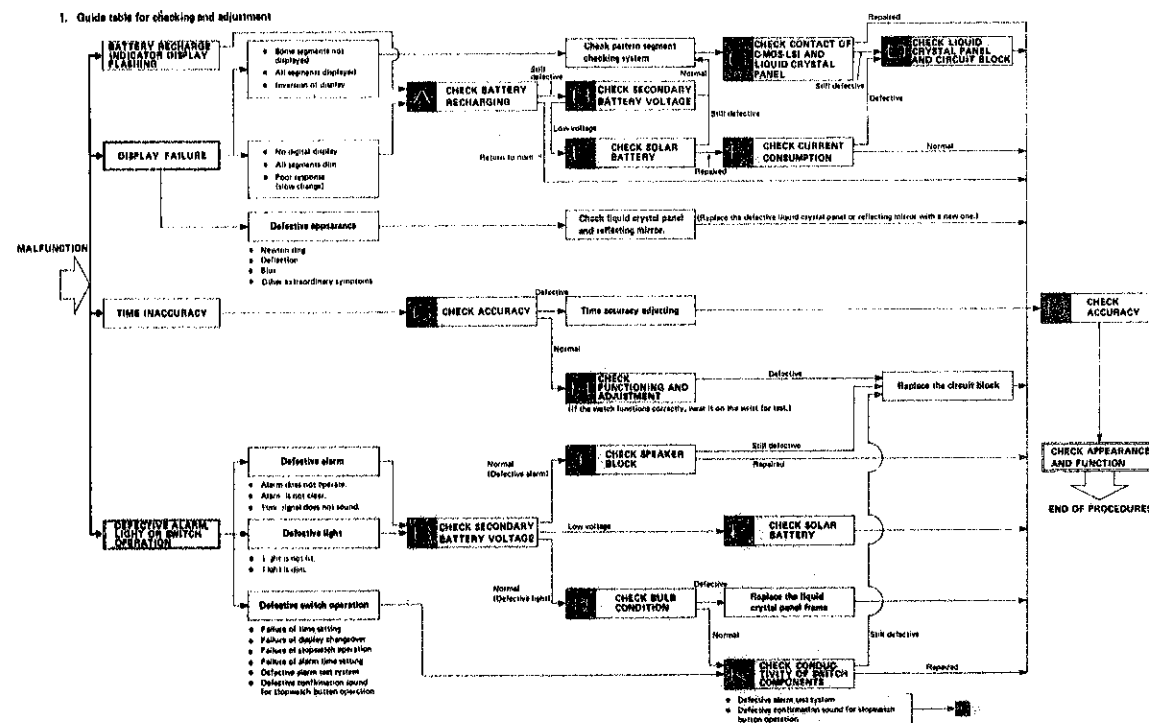

3. Procedures for checking and adjustment

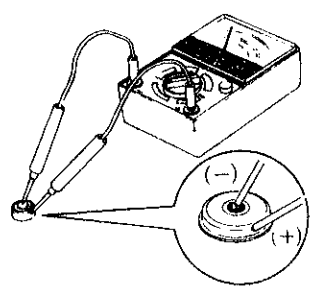
	Procedure	Result and repair						
△ CHECK BATTERY RECHARGING	<p>Check to see if the secondary battery is charged correctly. With the watch in the completed state (module with case), charge the secondary battery by exposing the solar battery to light under the following conditions.</p> <table border="1"> <thead> <tr> <th>Light</th> <th>Time (approx.)</th> </tr> </thead> <tbody> <tr> <td> <ul style="list-style-type: none"> • Direct sunlight </td> <td>2 ~ 3 minutes</td> </tr> <tr> <td> <ul style="list-style-type: none"> • Incandescent lamp: 100W/30cm (12 inches) directly under the light </td> <td>15 minutes</td> </tr> </tbody> </table> <p><i>Note:</i></p> <ul style="list-style-type: none"> • When charging under direct sunlight, be sure to charge the watch where there is sufficient air circulation so that it does not heat up excessively. • When charging under high temperature light sources such as an incandescent lamp, be careful not to place the watch too close to the light source. 	Light	Time (approx.)	<ul style="list-style-type: none"> • Direct sunlight 	2 ~ 3 minutes	<ul style="list-style-type: none"> • Incandescent lamp: 100W/30cm (12 inches) directly under the light 	15 minutes	<p>The watch functions correctly: Proceed to 11.</p> <p>(If the watch is charged insufficiently, the watch may malfunction. Be sure to charge the battery with the recommended light sources sufficiently.)</p> <p>The watch does not function correctly, or even if the watch is charged sufficiently, the watch malfunctions again: Proceed to 13.</p>
Light	Time (approx.)							
<ul style="list-style-type: none"> • Direct sunlight 	2 ~ 3 minutes							
<ul style="list-style-type: none"> • Incandescent lamp: 100W/30cm (12 inches) directly under the light 	15 minutes							
U CHECK SECONDARY BATTERY VOLTAGE	<p>Use the following procedures to check the voltage of the secondary battery.</p> <p>(1) Set up the Volt-ohm-meter. Range to be used: DC 3V</p> <p>(2) Measuring Probe Red (+) . . . Battery surface (+) Probe Black (-) . . . Battery surface (-)</p> <p style="text-align: center;">S-831</p>  <p>When there is battery electrolyte leakage, refer to "HOW TO CHECK BATTERY ELECTROLYTE LEAKAGE AND REPAIR" for repairing.</p>	<p>More than 1.5V: Normal Less than 1.5V: Defective Proceed to 14.</p>						

- (1) Remove the module from the case.
- (2) Disassemble the module.
- (3) Wipe off battery electrolyte on the circuit block.

1. Wipe off battery electrolyte with a cloth moistened with distilled water. If distilled water is not available, use tap water.

Note:

- Do not expose the trimmer condenser to water or alcohol, and if it is exposed, there may be a change in the condenser capacity and eventually in the time accuracy.
- Do not use a cloth which gives off lint such as gauze, flannel, etc.

When the circuit block is cleaned, be sure to clean the connecting portions.

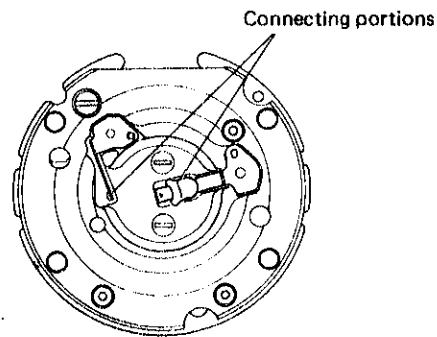

If the circuit block is badly contaminated with battery electrolyte, replace the circuit block with a new one.

Ex.

- When the circuit block is rusted.
- When even the liquid crystal panel side is contaminated with battery electrolyte.

2. Rinse with alcohol.
(If the cleaned portions remain wet with water, they will corrode with rust.)
3. Dry with warm air by using a dryer.
- (4) Clean the other parts. (Switch spring, etc.)
 1. Wipe off battery electrolyte on the other parts with a soft brush moistened with distilled water.
(If distilled water is not available, use tap water.)
 2. Rinse with alcohol.
 3. Dry with warm air by using a dryer.
- (5) Reassemble the module.
Replace the battery with a new one.
- (6) Check to see if the time and calendar function, the stopwatch function and the current consumption are normal.

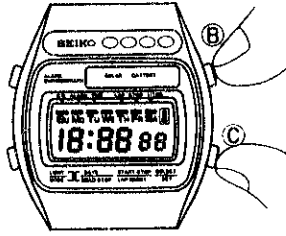
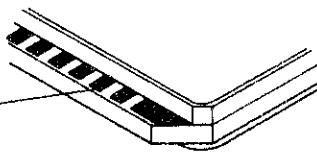
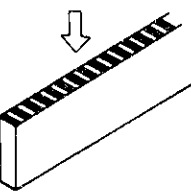
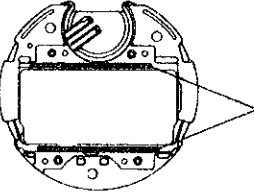
	Procedure	Result and repair
CHECK PATTERN SEGMENT CHECKING SYSTEM	<p>If some segments are dead or dim, set the mode for the time and calendar setting functions. Then depress buttons B and C together to find the defective segments. (If there is no defective segment, all segments light up.)</p> 	<p>Proceed to [] .</p>
CHECK CONTACT OF C-MOS-LSI ~ LIQUID CRYSTAL PANEL	<p>After removing the liquid crystal panel, check for poor conductivity of the liquid crystal panel, connector and C-MOS-LSI output terminal whose segments are found to be defective in "CHECK PATTERN SEGMENT CHECKING SYSTEM". (Refer to the "Relationship between the segment and the C-MOS-LSI output terminal" on page 10.) Use a microscope for checking.</p> <ol style="list-style-type: none"> (1) Check for dust, lint and other contamination on the liquid crystal panel electrode.  <p>Liquid crystal panel electrode</p> <ol style="list-style-type: none"> (2) Check for any contamination, scratch, crack and break of the connector.  <p>Be sure to check the connecting portion of the liquid crystal panel and the circuit block carefully.</p> <ol style="list-style-type: none"> (3) Check for dust, lint and other contamination on the output terminal of the circuit block.  <p>Output terminal of the circuit block</p>	<p>Uncontaminated: Normal Proceed to [] (2).</p> <p>Contaminated: Defective Wipe off any foreign matter.</p> <p>No contamination, scratch, crack or break: Normal Proceed to [] (3).</p> <p>Contaminated: Defective Clean.</p> <p>Scratched, cracked or broken: Defective Replace the connector with a new one.</p> <p>Uncontaminated: Normal Proceed to [] .</p> <p>Contaminated: Defective Wipe off any foreign matter.</p>

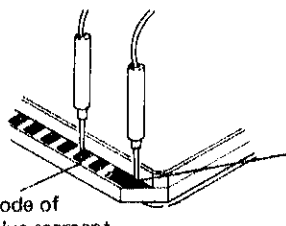
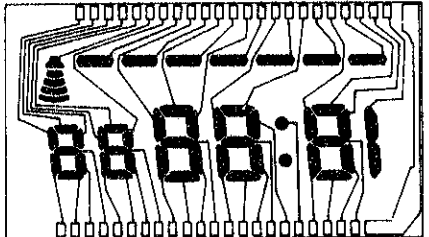
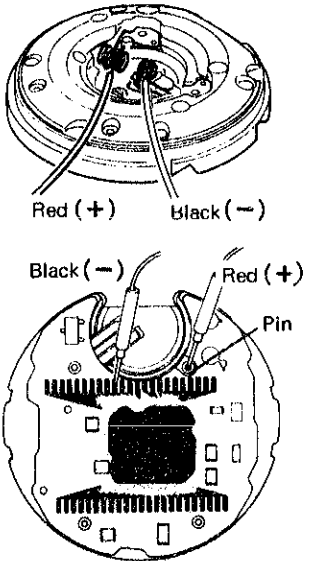
Procedure	Result and repair
<p>Check to see if the liquid crystal panel and the circuit block function correctly. (Refer to the "Relationship between the segment and the C-MOS-LSI output terminal" on page 10.)</p> <p>(1) Check liquid crystal panel.</p> <p>1. Set up the Volt-ohm-meter. Range to be used: OHMS R x 1 ~ R x 1K</p> <div style="border: 1px solid black; padding: 5px; margin: 10px 0;"> <p>Note:</p> <ul style="list-style-type: none"> Any range will do if more than 3V is applied to the terminal of the Volt-ohm-meter. When the Volt-ohm-meter other than SEIKO Volt-ohm-meter S-831 is used, all segments may not be lit. If any segment does not light, change the range to the one (R x 10K) which is higher in resistance than R x 1K. </div> <p>2. Remove the liquid crystal panel from the module and turn it upside down.</p> <p>3. Measuring (Check to see if the corresponding segment lights up.)</p>  <div style="border: 1px solid black; padding: 5px; margin: 5px 0;"> <p>Note: Either red or black probe will do.</p> </div> <p>Common electrode (Either red or black probe must be applied to the common electrode)</p> <p>Electrode of defective segment</p>  <p>(2) Check the circuit block output voltage.</p> <p>1. Set up the Volt-ohm-meter. Range to be used: DC 3 V</p> <p>2. Attach the electricity supplier (S-833) to the circuit block. Spring (+): Plus terminal of battery connection Spring (-): Battery connection</p> <p>3. Measuring Probe Red (+): Pin for the liquid crystal panel holder screw (Shown in the illustration on the right.) Probe Black (-): Each portion of the output terminal of the C-MOS-LSI. (If some displays are defective, apply to the corresponding output terminals of the C-MOS-LSI.)</p> 	<p>Lights up: Normal Proceed to D (2).</p> <p>Does not light up: Defective Replace the liquid crystal panel with a new one.</p> <p>More than 0.8V: Normal Return to D.</p> <p>Less than 0.8V: Defective Replace the circuit block with a new one.</p>

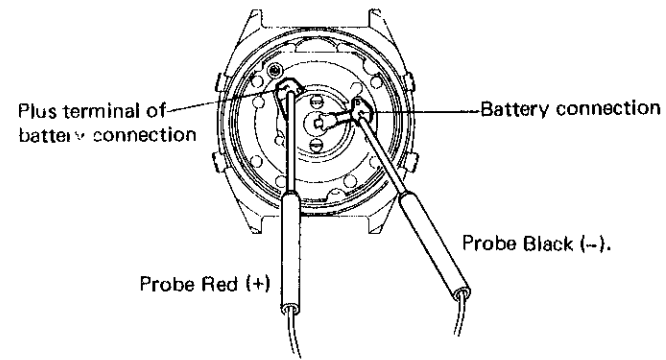
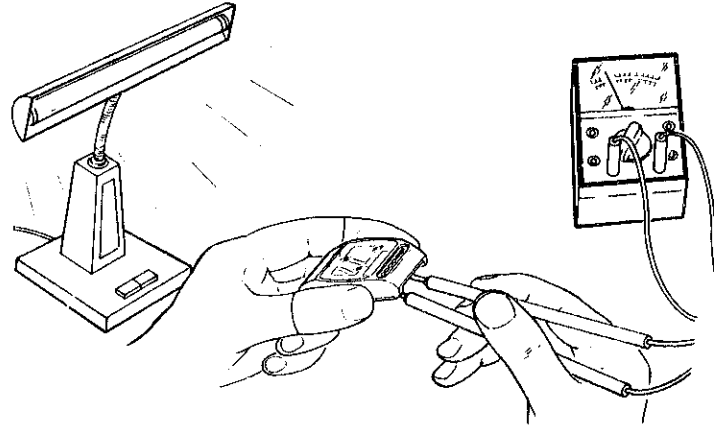
Procedure	Result and repair						
<p>(1) Check to see if the current flow to the solar battery and the secondary battery is normal.</p> <p>1. Set up the Volt-ohm-meter. The volume of electricity to be generated varies depending upon the light source. Set the range by referring to the table below.</p> <table border="1" style="width: 100%; text-align: center;"> <thead> <tr> <th>Light</th> <th>Range</th> </tr> </thead> <tbody> <tr> <td> <ul style="list-style-type: none"> White fluorescent lamp: 10 ~ 30W/20 ~ 40 cm (8 ~ 16 inches) directly under the light </td> <td>DC 30 μA</td> </tr> <tr> <td> <ul style="list-style-type: none"> Direct sunlight </td> <td>DC 1.2 mA</td> </tr> </tbody> </table> <p>2. Measuring</p> <p>i. Set the module in the casebezel without the secondary battery. Apply the probes of the Volt-ohm-meter to the battery connections.</p>  <p>Plus terminal of battery connection Battery connection Probe Red (+) Probe Black (-)</p> <p>ii. With the probes applied to the battery connections, expose the display panel side to the light, and check to see if the pointer of the Volt-ohm-meter swings.</p>  <div style="border: 1px solid black; padding: 5px; margin: 10px 0;"> <p>Note:</p> <ul style="list-style-type: none"> Be careful not to shadow the display panel side from the light by your hand, etc. Be sure to wipe off any contamination on the solar battery portion of the glass. </div>	Light	Range	<ul style="list-style-type: none"> White fluorescent lamp: 10 ~ 30W/20 ~ 40 cm (8 ~ 16 inches) directly under the light 	DC 30 μ A	<ul style="list-style-type: none"> Direct sunlight 	DC 1.2 mA	<p>The pointer swings: Normal Proceed to Replace the secondary battery.</p> <p>The pointer does not swing: Defective Proceed to D (2).</p>
Light	Range						
<ul style="list-style-type: none"> White fluorescent lamp: 10 ~ 30W/20 ~ 40 cm (8 ~ 16 inches) directly under the light 	DC 30 μ A						
<ul style="list-style-type: none"> Direct sunlight 	DC 1.2 mA						

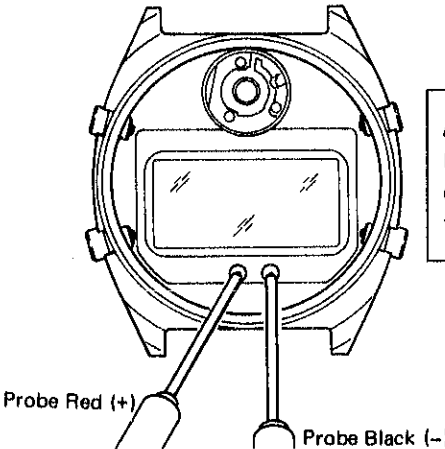
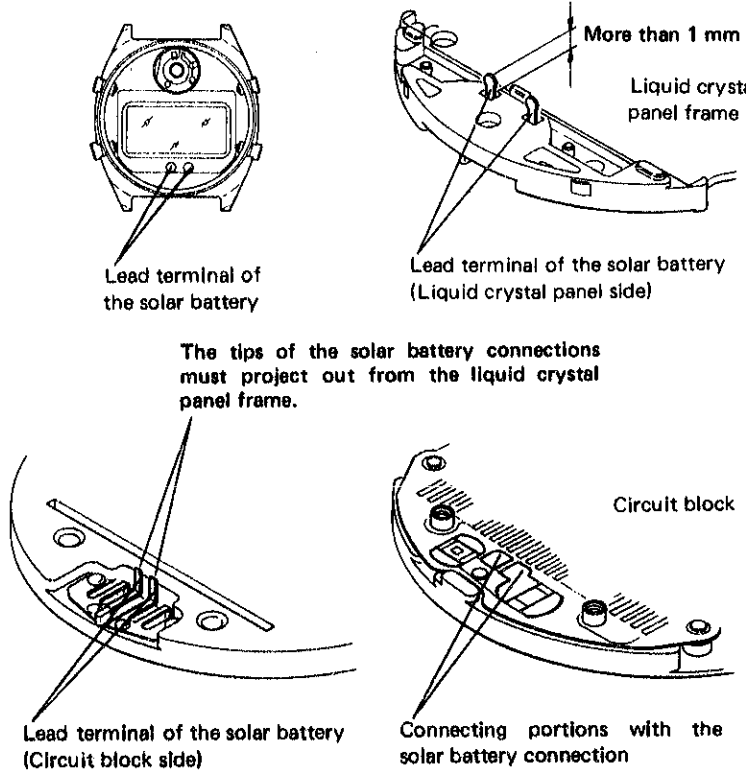
	Procedure	Result and repair
CHECK SOLAR BATTERY	<p>(2) Check to see if the solar battery functions correctly. Remove the module from the case bezel. Apply the probes of the Volt-ohm-meter to the lead terminals of the solar battery, which are positioned behind the panel cover. Check to see if the pointer of the Volt-ohm-meter swings by following the same procedures as in (1).</p>  <p>Probe Red (+) Probe Black (-)</p> <div style="border: 1px solid black; padding: 5px; margin: 10px 0;"> <p>Note: Be sure that there is no contamination on the lead terminal of the solar battery.</p> </div> <p>(3) Check conductivity of the lead terminals of the solar battery, the liquid crystal panel frame and the circuit block. Check for any contamination and deformation of the connecting portions of the lead terminals of the solar battery, the solar battery connections of the liquid crystal panel frame and the solar battery connections of the circuit block.</p> 	<p>The pointer swings: Normal Proceed to F (3).</p> <p>The pointer does not swing: Defective Proceed to Replace the panel cover (with the solar battery) with a new one.</p> <p>Uncontaminated or not deformed: Normal Replace the circuit clock.</p> <p>Contaminated or deformed: Defective Wipe off any foreign matter or correct the deformation.</p>

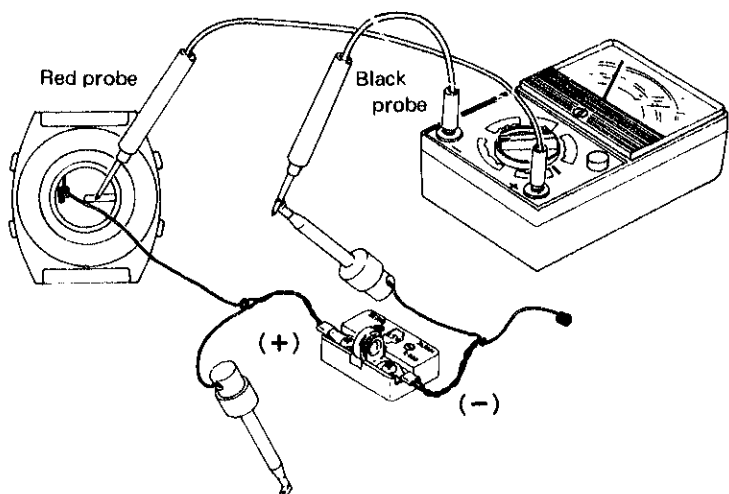
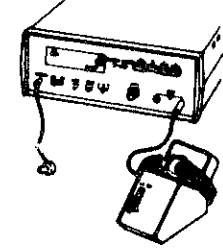
	Procedure	Result and repair
CHECK CURRENT CONSUMPTION	<p>Check to see if the current consumption is normal. (Any watch function will do.)</p> 	<p>Less than $3\mu\text{A}$: Normal Proceed to F.</p> <p>More than $3\mu\text{A}$: Defective Proceed to I.</p>
CHECK ACCURACY	<p>Check gain and loss of time.</p> <p>(1) Set up the Quartz Tester. As there are several types of Quartz Testers, refer to the respective instruction manual.</p> <p>(2) Measuring</p> 	<p>If the watch tends to gain or lose, proceed to Time accuracy adjusting.</p> <p>Time accuracy is adjusted by turning the trimmer condenser.</p>

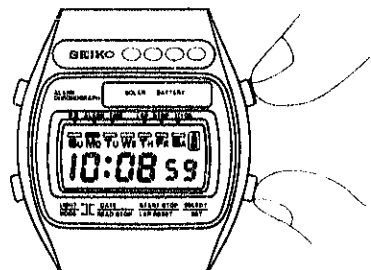
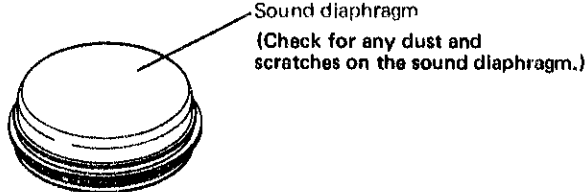
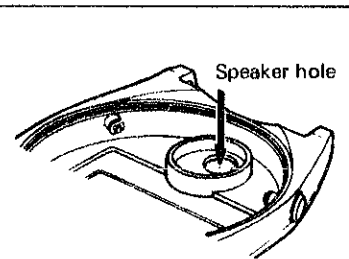
	Procedure	Result and repair
CHECK FUNCTIONING AND ADJUSTMENT	<p>Check functioning and adjustment.</p> <p>(1) Check the stopwatch function. Check to see if "start", "stop", "lap", "lap release" and "reset" function correctly.</p> <p>(2) Check the alarm time setting function. Set the hour and minute more than one cycle and check to see if the digits are advancing correctly.</p> <p>(3) Check the time and calendar setting function. Check the time and calendar digits more than one cycle for each unit and check to see if each digit is advancing correctly.</p>	<p>Functions correctly and can be adjusted: Normal Wear the watch on the wrist to check time accuracy.</p> <p>Does not function correctly or cannot be adjusted: Defective Proceed to Replace the circuit block.</p>
CHECK SPEAKER BLOCK	<p>(1) Check to see if the speaker sounds the alarm correctly. Check to see if the speaker sounds when the watch is in the time function and when the two buttons on the right side are depressed together.</p>  <p>(2) Check for any dust and scratches on the sound diaphragm of the speaker block.</p>  <p><i>Note:</i> Make sure that the speaker hole isn't clogged with dust.</p> 	<p>Speaker sounds: Normal Set the alarm time and if the alarm does not operate at the required time, proceed to Replace the circuit block.</p> <p>Speaker does not sound or it sounds but not clear: Defective Proceed to 1 (2).</p> <p>No dust or scratches: Normal Proceed to 1 (3).</p> <p>Dust: Defective Wipe off any foreign matter with a cloth moistened with cleaning solution.</p> <p>Scratched: Defective Replace the speaker block.</p>

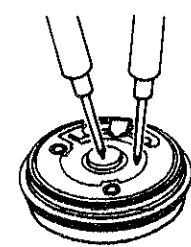
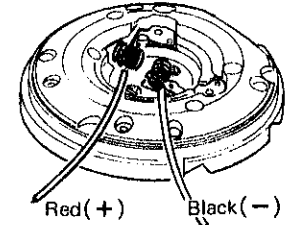
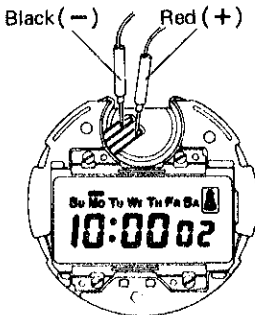
	Procedure	Result and repair
CHECK SPEAKER BLOCK	<p>(3) Check for any broken coil wire and short-circuit of the coil of the speaker block.</p> <p>1. Set up the Volt-ohm-meter. Range to be used: OHMS R x 1</p> <p>2. Measuring Apply the probes of the Volt-ohm-meter to the lead terminal of the speaker block.</p>  <div data-bbox="2012 766 2448 945" style="border: 1px solid black; padding: 5px;"> <p><i>Note:</i> Be careful not to break the coil wire when the probes are applied to the coil terminal.</p> </div> <p>(4) Check to see if the output signal of the circuit block is transmitted to operate the speaker block.</p> <p>1. Set up the Volt-ohm-meter. Range to be used: DC 3 V</p> <p>2. Attach the current supplier (S-833) to the module.</p> <ul style="list-style-type: none"> Use the current supplier (S-833) as shown in the illustration on the right. Make the alarm ready for sounding by adjusting the switch spring. (Synchronize the alarm time by the time indicated by the time display.)  <p>3. Measuring Apply the probes of the Volt-ohm-meter to the output terminals for speaker of the circuit block as shown in the illustration on the right. Check to see if the pointer of the Volt-ohm-meter swings twice every second.</p> 	<p>Resistance 30Ω ~ 150Ω: Normal Proceed to 1 (4).</p> <p>Less than 30Ω or more than 150Ω: Defective Proceed to Replace the speaker block.</p> <p>Swings: Normal Proceed to Replace the speaker block.</p> <p>Does not swing: Defective Proceed to Replace the circuit block.</p>

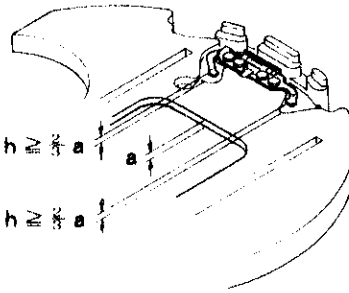
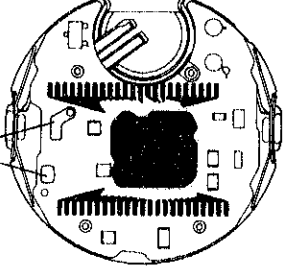
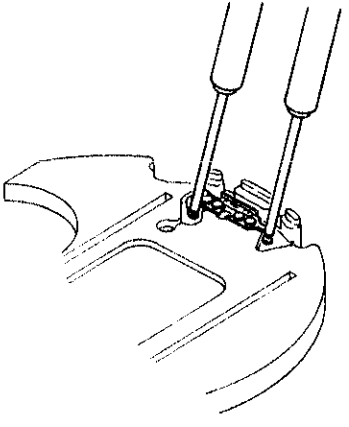
Procedure	Result and repair
<p>(1) Check to see if the bulb lead terminals touch the lead terminal of the circuit block.</p> <p>1. Check to see if the two bulb lead terminals protrude by more than 0.3 mm from the back side of the liquid crystal panel frame. Also check for any dust, lint and other contamination of the bulb lead terminal. Protrusion "h" of the bulb lead terminal should be two-thirds or more of the thickness "a" of the liquid crystal panel frame.</p>  <p>2. Check for any contamination on the bulb lead terminal of the circuit block.</p> 	<p>Protrudes by more than 0.3mm: Normal</p> <p>Protrudes by less than 0.3mm: Defective Pull out by using tweezers.</p> <p>No dust, lint or contamination: Normal Proceed to (2).</p> <p>Dust, lint or contaminated: Defective Wipe off any foreign matter.</p>
<p>(2) Check to see if there is a broken filament in the bulb and if there is any break in the welded portion of the bulb lead terminal.</p> <p>1. Set up the Volt-ohm-meter. Range to be used: OHMS R x 1</p> <p>2. Measuring Apply the two probes of the Volt-ohm-meter to the bulb lead terminal as shown in the illustration.</p>  <p>Note: Either red or black probe will do.</p>	<p>Bulb lights up: Normal Proceed to .</p> <p>Bulb does not light up: Defective Proceed to Replace the liquid crystal panel frame.</p>

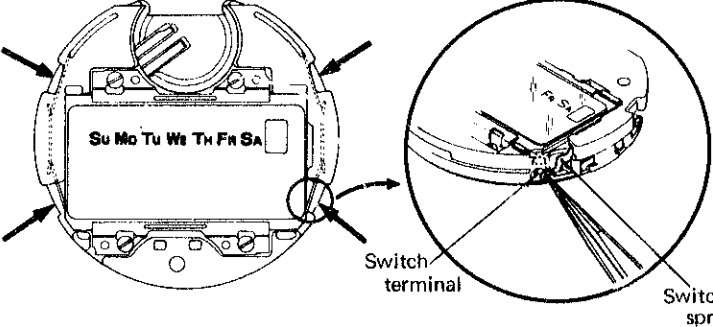
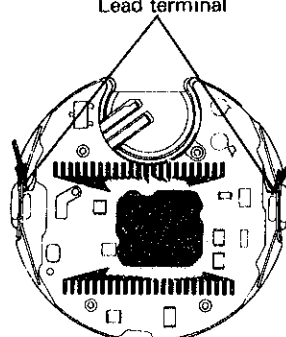
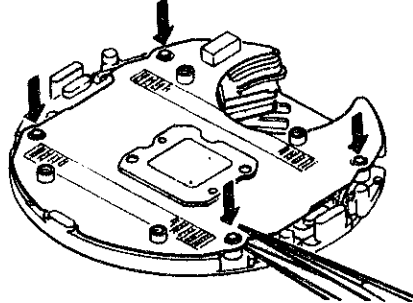
Procedure	Result and repair
<p>Check to see if the switch spring functions correctly.</p> <p>(1) Check to see if the switch springs (four arrow-marked portions shown in the illustration below) function correctly when they are pushed in.</p> <p>1. Check to see if the four arrow-marked springs touch the switch terminals of the circuit block when they are pushed in with the tips of the tweezers and that they do not touch the switch terminals of the circuit block when released.</p> 	<p>Functions correctly: Normal</p> <p>Does not function correctly: Defective If the switch springs do not function correctly after the switch springs are set correctly, proceed to Replace the switch spring.</p> <p>No dust, lint or contamination: Normal Proceed to (2).</p> <p>Dust, lint or contaminated: Defective Wipe off any foreign matter.</p>
<p>2. Check for dust, lint and other contamination on the connecting portions.</p> <p>(2) Check to see if the switch springs touch the lead terminal of the circuit block.</p> <p>1. Check to see if the two arrow-marked portions touch correctly when the panel frame is removed.</p> 	<p>Touch: Normal Do not touch: Defective Adjust by using tweezers so that the lead terminal of circuit block touches the switch spring.</p> <p>No dust, lint or contamination: Normal Proceed to (3).</p> <p>Dust, lint or contaminated: Defective Wipe off any foreign matter.</p>
<p>2. Check for dust, lint and other contamination on the connecting portions.</p> <p>3. Check to see if the pins for the switch terminals are fixed firmly in the circuit board. Check to see if the four arrow-marked pins for the switch terminals are fixed firmly in the circuit board by slightly lifting the circuit board with tweezers as shown in the illustration on the right.</p> 	<p>Fixed firmly: Normal Replace the circuit block. (Defective C-MOS-LSI)</p> <p>Not fixed firmly: Defective Replace the circuit block. (The pins for the switch terminals are not fixed firmly.)</p> <p>Defective alarm test system or functioning sounds of stopwatch buttons indicate they do not function correctly. Proceed to .</p>