

SEIKO

QUARTZ

Cal. 6020A

PARTS LIST

Cal. 6020A

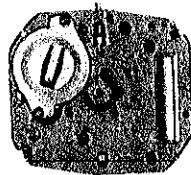
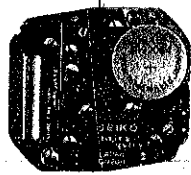

122 920



125 920



126 920



☆221 920



231 920



241 920



261 920



☆271 920



281 920



282 810

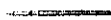

354 920



383 920



384 920



388 920



391 920



399 920



491 589



701 920



766 920



4001 920



4002 920



4146 920

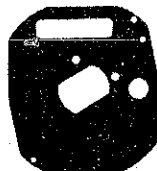

4216 920



4216 921



4239 920



4259 920



4270 920



☆Maxell SR920SW



022 424



022 427



022 764

3/1

Cal. 6020A

Characteristics

Casing diameter: ϕ 24.0 mm
 Maximum height: 2.0 mm without battery
 Jewels: 8 j
 Frequency of quartz crystal oscillator: 32,768 Hz (Hz = Hertz Cycle per second)
 Driving system: Step motor system (2 poles)
 Regulation system: Trimmer condenser & Rotary step switch type

PART NO.	PART NAME	PART NO.	PART NAME
122 920	Center wheel bridge	023 347	Tube for casing clamp
125 920	Train wheel bridge	027 041	Tube for train wheel bridge
126 920	Additional train wheel bridge	027 043	Tube for additional train wheel bridge
☆221 920	Center wheel & pinion	027 044	Tube for anti-magnetic shield plate screw
☆221 922	Center wheel & pinion	027 045	Tube for yoke screw
☆221 924	Center wheel & pinion	027 630	Bush for battery connection (-)
231 920	Third wheel & pinion	027 858	Second setting lever adjusting pin
241 920	Fourth wheel & pinion	027 859	Setting lever pin
261 920	Minute wheel	027 860	Battery connection (-) pin A
☆271 920	Hour wheel	027 861	Battery connection (-) pin B
☆271 921	Hour wheel	027 865	Reset pin
☆271 922	Hour wheel	☆Maxell SR920SW	Silver oxide battery
281 920	Setting wheel		
282 810	Clutch wheel		
354 920	Winding stem		
383 920	Setting lever		
384 920	Yoke (Clutch lever)		
388 920	Setting lever spring		
391 920	Second setting lever		
399 920	Casing clamp		
491 589	Dial washer		
701 920	Fifth wheel & pinion		
766 920	Intermediate minute wheel		
4001 920	Circuit block		
4002 920	Coil block		
4146 920	Step rotor		
4216 920	Insulator		
4216 921	Insulator for battery		
4239 920	Rotor stator		
4247 920	Battery connection (-) insulating bush		
4247 921	Insulating bush for reset pin		
4259 920	Anti-magnetic shield plate		
4270 920	Battery connection (-)		
022 424	Train wheel bridge screw		
022 424	Circuit block screw		
022 424	Additional train wheel bridge screw		
022 424	Anti-magnetic shield plate screw		
022 424	Yoke screw		
022 427	Casing clamp screw		
022 764	Dial screw		
011 547	Lower hole jewel for third wheel		
011 547	Lower hole jewel for fifth wheel		
011 547	Lower hole jewel for step rotor		
023 347	Tube for setting lever spring screw		

☆ ⇔ Please see remarks on the reverse page.
 Part numbers in light letters are not shown in photos.

Cal. 6020A

Remarks:

Center wheel & pinion, Hour wheel.
There are three different types as specified below.

Combination:

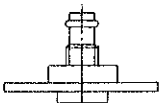
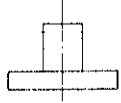
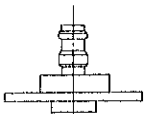
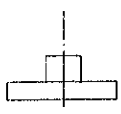
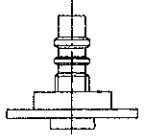
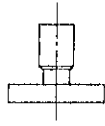
Type	Center wheel & pinion	Hour wheel
a. (All types of dials excluding the types classified in b and c)		Silver 
	☆221 920	☆271 920
b. (Dials for thin type models)		Gold 
	☆221 922	☆271 921
c. (Dials with index jewels)		
	☆221 924	☆271 922

Battery

☆ Maxell SR920SW.....The applied battery for this calibre might be added the substitutive in the future.
In that case, please refer to separate "BATTERIES FOR SEIKO QUARTZ WATCHES".

TECHNICAL GUIDE

SEIKO
QUARTZ

CAL. 6020A

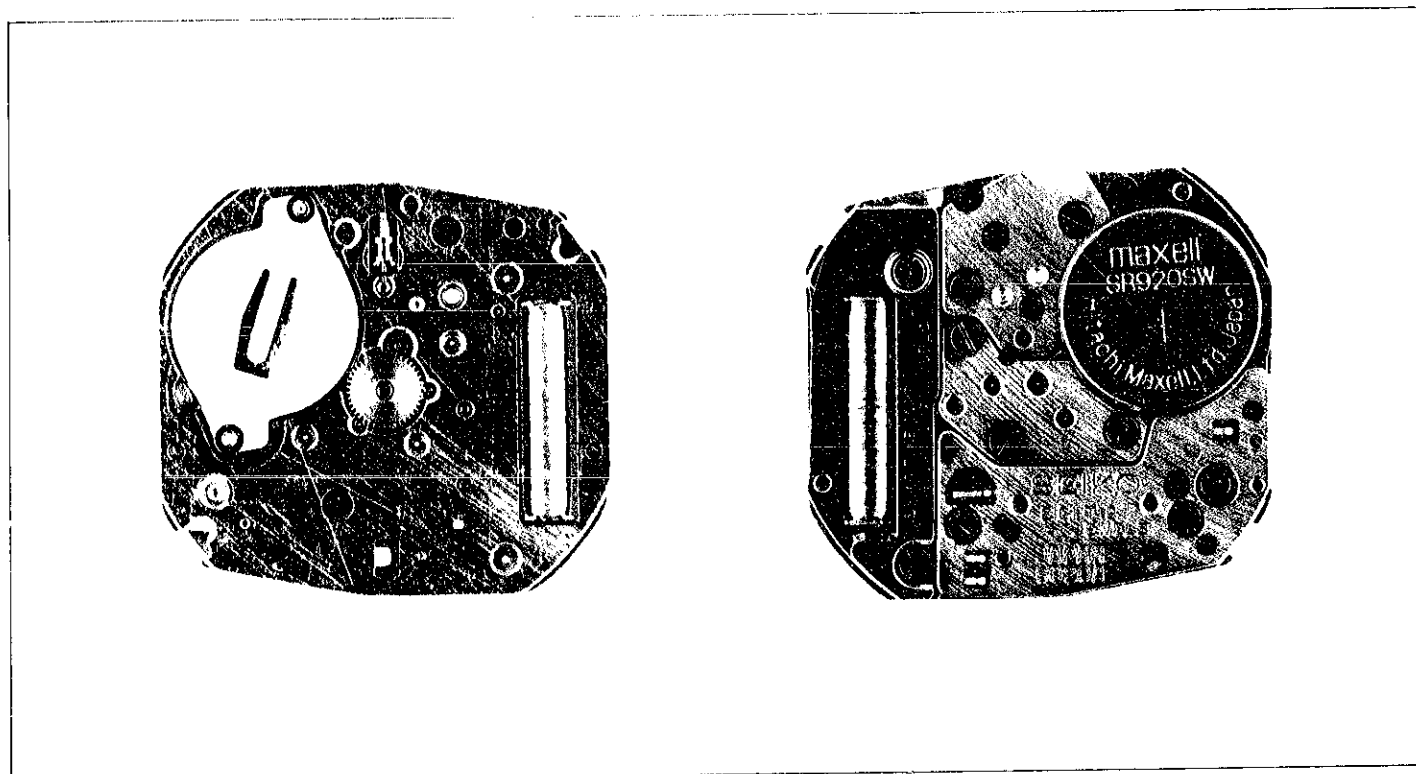

CONTENTS

I. SPECIFICATIONS AND FEATURES	1
1. Specifications	1
2. Features	1
3. Measuring daily rate	2
4. Case back construction	2
II. DISASSEMBLING, REASSEMBLING AND LUBRICATING	4
1. Disassembling, reassembling and lubricating	4
III. CHECKING AND ADJUSTMENT	11
1. Guide table for checking and adjustment	11
2. Procedures for checking and adjustment	12
A : Check output signal	12
B : Check battery voltage	12
• How to check battery electrolyte leakage and repair	12
C : Check battery conductivity	14
D : Check circuit block conductivity	14
E : Check circuit block output terminal conductivity	14
F : Check coil block	16
G : Check output signal	16
H : Check second setting condition	16
I : Check reset condition	18
J : Check gear train	18
K : Check accuracy	18
L : Check current consumption	20

I. SPECIFICATIONS AND FEATURES

1. Specifications

Item	Cal. No.	6020A
Time indication		Hour and minute hands
Additional mechanism		Electronic circuit reset switch
Crystal oscillator		32,768 Hz (Hz = Hertz Cycles per second)
Loss/gain		Loss/gain at normal temperature range Monthly rate : less than 15 seconds (Annual rate : less than 3 minutes)
Movement size		∅24.6 mm (20mm between 3 o'clock and 9 o'clock sides) 22mm between 12 o'clock and 6 o'clock sides)
Casing diameter		∅24.0 mm
Height		2.0 mm (battery portion: 2.1 mm)
Operational temperature range		-10°C ~ +60°C (14°F ~ 140°F)
Driving system		Step motor system (2 poles/Moves at 10-second intervals.)
Regulation system		Trimmer condenser
Battery power		Silver oxide battery Maxell SR920SW Battery life is approximately 3 years. Voltage: 1.55V
Jewel		8 jewels

2. Features

- (1) A movement 2.0 mm in thickness makes it possible for Cal. 6020A to be a dress watch fashionable in design.
- (2) The movement has been made thinner, but has the same additional features as the existing SEIKO quartz watches, and is as easy to disassemble and reassemble because of its completely simplified structure and design.
- (3) The battery life has been lengthened to approximately 3 years through the use of the current saving MOS-IC, and the newly developed, highly efficient step motor.

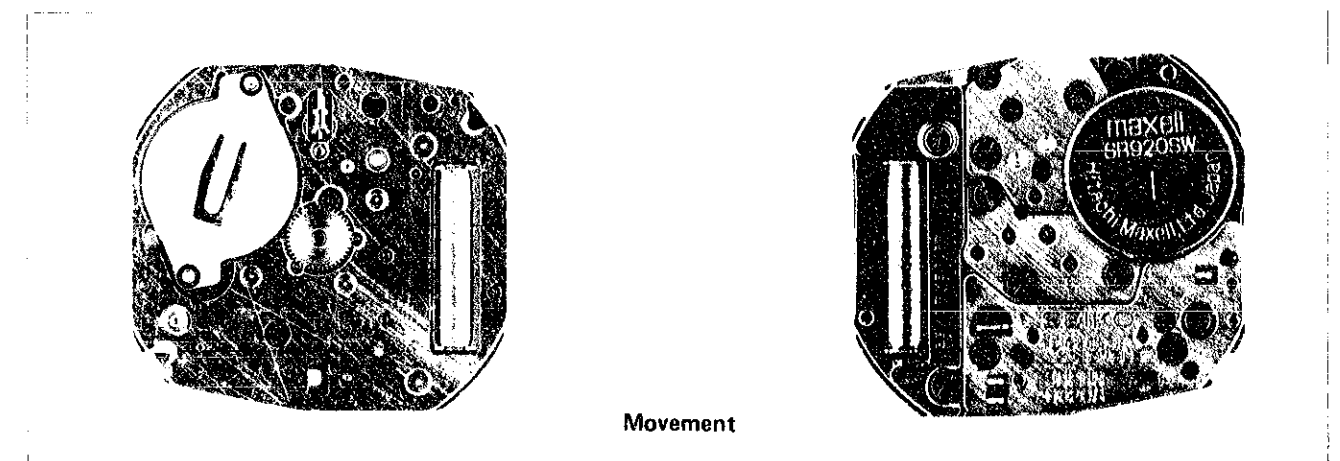

3. Measuring daily rate

- Use the Electro-magnetic microphone. In the ordinary quartz watch, the frequency (time accuracy) of the crystal oscillator is adjusted by correcting the quartz crystal oscillator's frequency with the trimmer condenser. Cal. 6020A, however, uses a method in which a loss or gain is corrected within the MOS-IC itself and not by adjusting the oscillator's frequency. Therefore, if such a microphone as the Ultrasonic microphone (US-32) which picks up frequency of the crystal oscillator is used to measure the daily rate of this watch, it will be impossible to measure the daily rate accurately.
- Cal. 6020A, though moving at 10-second intervals, transmits pulses once every two seconds for daily rate measurement. Therefore, any range 2, 4, 6 or 10 (0.1, 0.01), will do to measure the daily rate.

4. Case back construction

In addition to the case back of ordinary structure, a bayonet type case back is used for Cal. 60 series. Before disassembling and reassembling the bayonet type case back, read the following instructions carefully.

(1) Advantages of the bayonet type case back

- It can be opened and closed by simply turning it approximately 45 degrees, thus eliminating the need for turning it several times to open and close, as is required of the screw type case back.
- It can be opened and closed readily by using a simple instrument. (in the same manner as with the bayonet type battery hatch.)

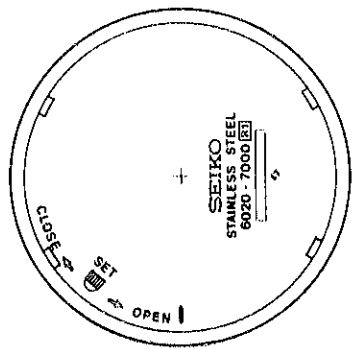

How to identify the bayonet type case back

- There are four spanner grooves on the case back for opening and closing as shown in the illustration above. (Six spanner grooves are provided for the screw type case back.)
- The "CLOSE SET OPEN" mark is inscribed on the bayonet case back.

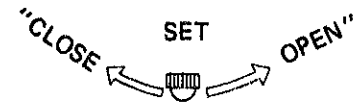

(2) How to open and close the bayonet type case back

Bayonet type case back is closed.

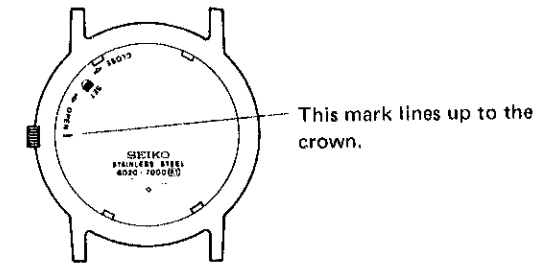

Fig. 1

Bayonet type case back is ready for opening.

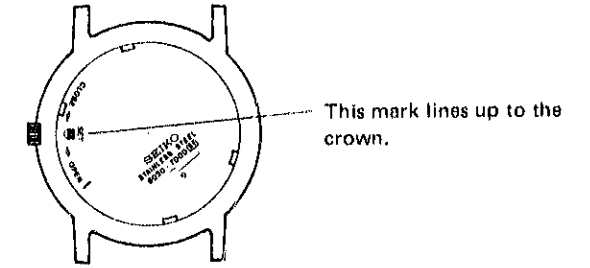
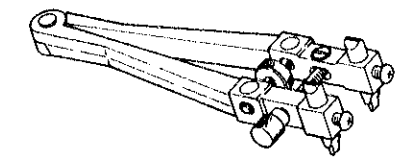
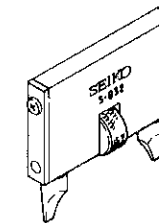

Fig. 2

Case opener



- Use case opener with two claws.
- To open, turn in the direction of "OPEN" from the "CLOSE" position (Fig. 1) until the " SET " mark lines up to the crown.
- To close, set the case back so that the " SET " mark lines up to the crown. Then turn it in the direction of "CLOSE" (Fig. 2) so that " | " mark lines up to the crown.

Note: When opening and closing the bayonet type case back, be careful not to turn it excessively as this may damage the case.

II. DISASSEMBLING, REASSEMBLING AND LUBRICATING

1. Disassembling, reassembling and lubricating

• Disassembling and reassembling

Disassembling procedures Figs. : ① → ③②

Reassembling procedures Figs. : ③② → ①

• Lubricating

The following marks in the diagrams for disassembling and reassembling indicate the types of oil, oil quantity to be applied and the lubricating portions. Be sure to lubricate according to the marks.

Types of oil		Oil quantity	
	Moebius A		Normal quantity
	SEIKO Watch Oil S-6		Small quantity

• After-sale servicing instruments and materials

Use the movement holder S-667.

• List of screws used

The following three types of screws are used in Cal. 6020A. Some case models are not provided with casing clamp screw.

Shape	Parts No.	Name	Shape	Parts No.	Name
	022427	Casing clamp screw (2 pcs.)		022424	Train wheel bridge screw (3 pcs.)
					Circuit block screw (2 pcs.)
					Additional train wheel bridge screw (2 pcs.)
	022764	Dial screw (2 pcs.)			Anti-magnetic shield plate screw (2 pcs.)
					Yoke screw (1 pc.)

• General remarks for disassembling and reassembling

- Cal. 6020A is a thin watch, and the infiltration of dust, lint, etc. into its case may cause the watch to stop. Be extremely careful not to let any dust, lint, etc. into the case. Also be careful not to damage the bridges, main plate, etc. as they are very thin.
- The movement of Cal. 6020A is thin and the clearance between the hands is less than that for ordinary watches. When reassembling the hands, be very careful that they do not touch each other. Also, as the hands are thinner than the ordinary ones, be careful not to bend them when handling.

(1) Remove the movement from the case.

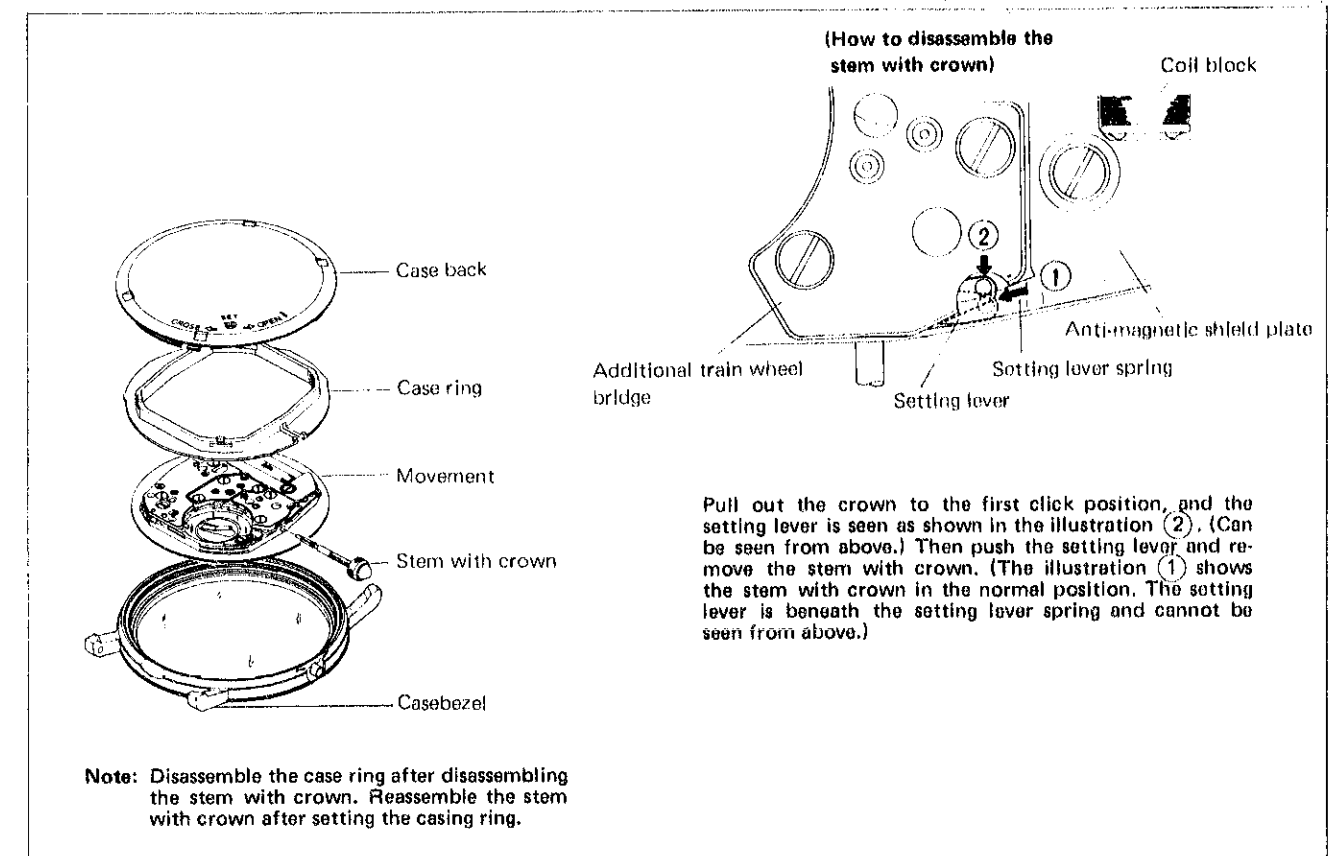

(2) Disassembling, reassembling and lubricating of the minute hand ~ hour wheel

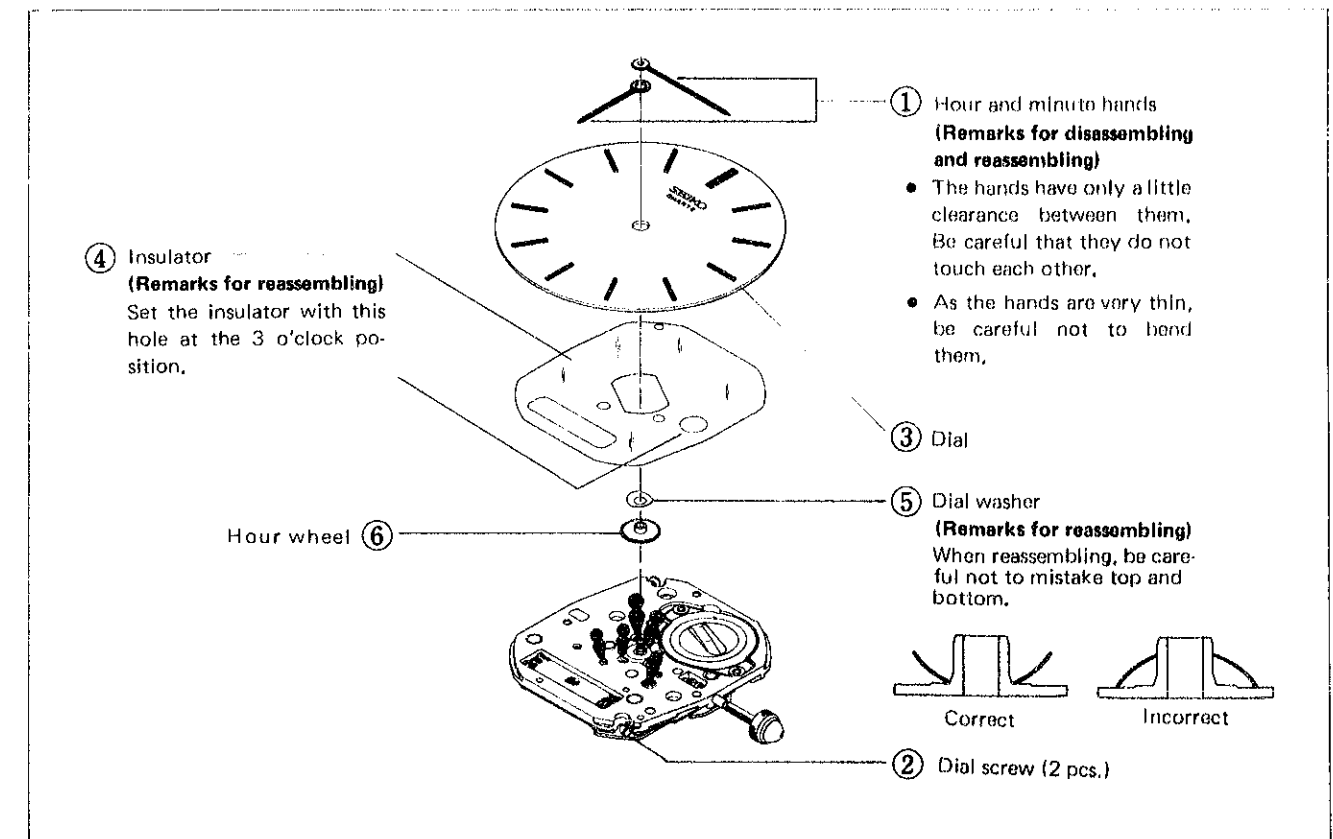

(3) Disassembling, reassembling and lubricating of the circuit block ~ second setting lever ~ setting wheel

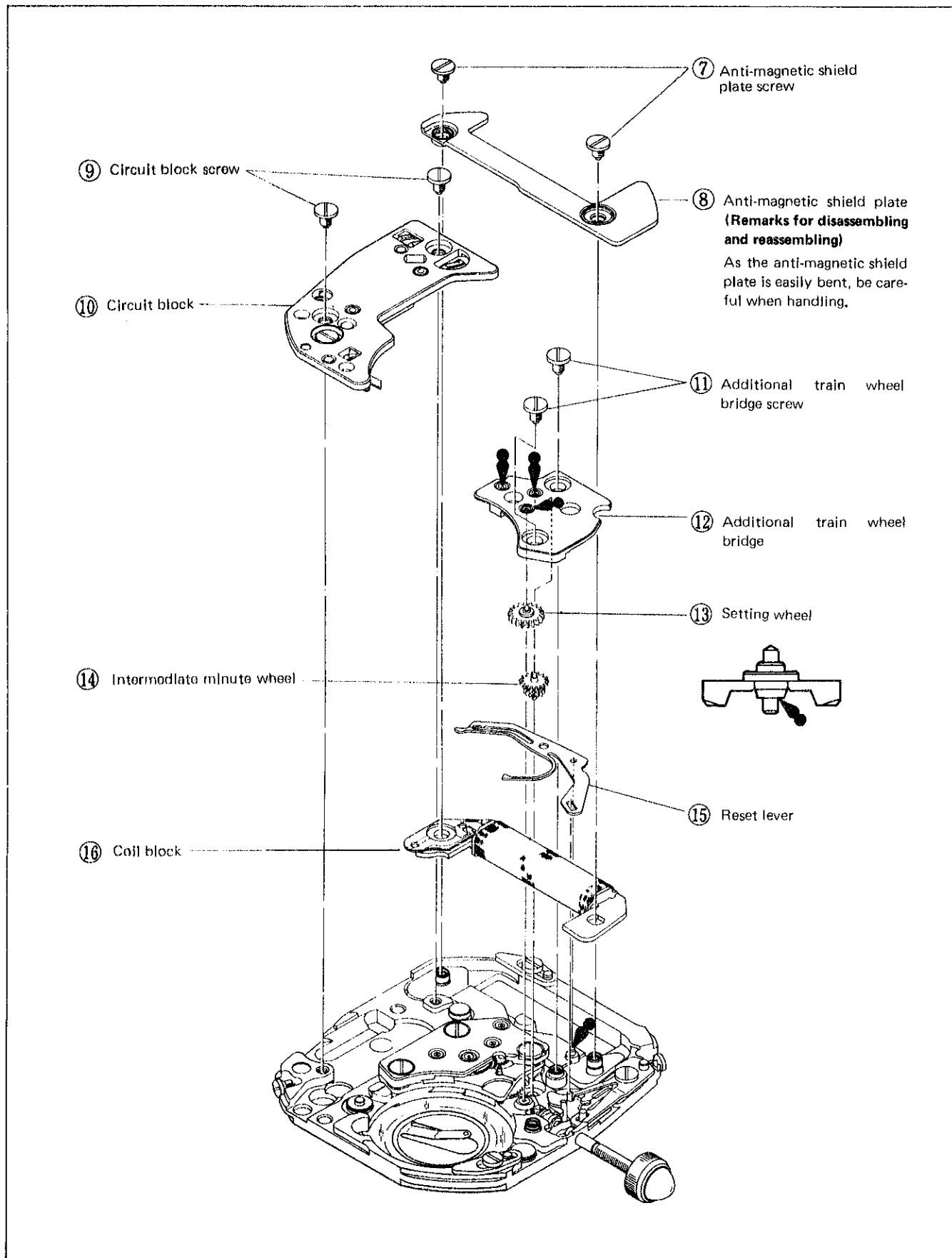

Remarks for disassembling and reassembling

⑩ Circuit block

Remarks for disassembling and reassembling

- Be careful not to cut the copper leaf patterns on the back side of the circuit block.
- Do not touch the elements except when it is required.

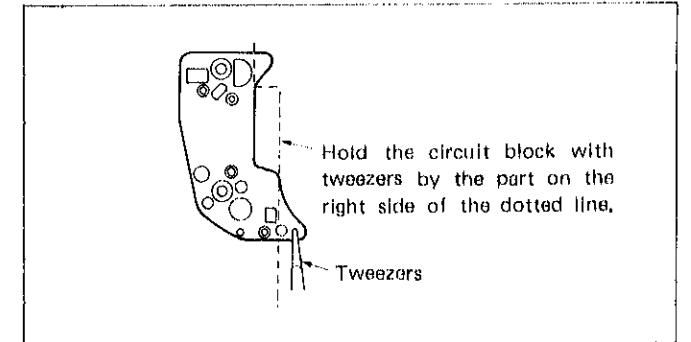

⑬ Setting wheel

Remarks for reassembling

- Be careful not to mistake the upper side for the lower side.

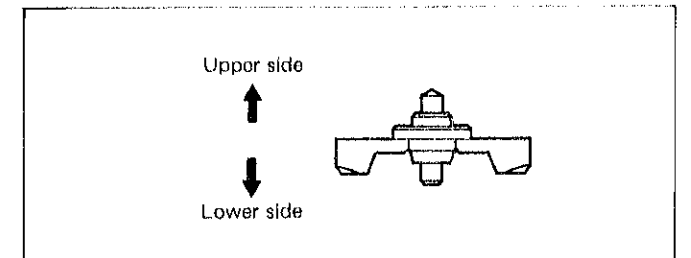

⑮ Reset lever

Remarks for reassembling

- Be sure to reassemble with the crown in the normal position. (Otherwise, the reset lever may break the teeth of the fifth wheel.)

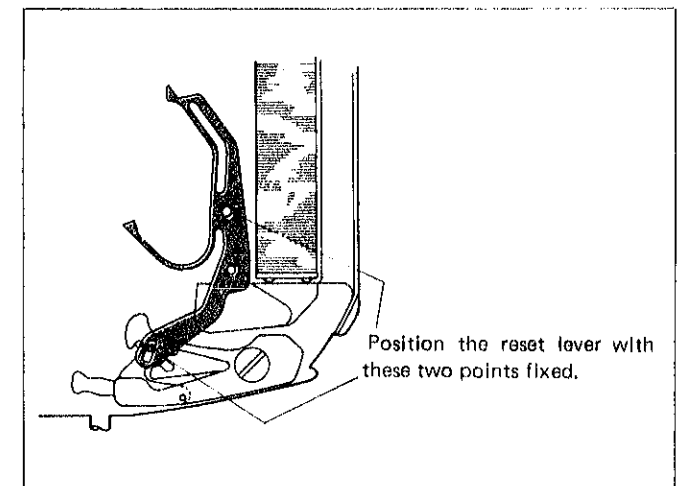

⑯ Coil block

Remarks for disassembling and reassembling

- Be careful not to scratch or bend the coil wire and the lead terminal. Hold the circuit block as shown in the illustration below.

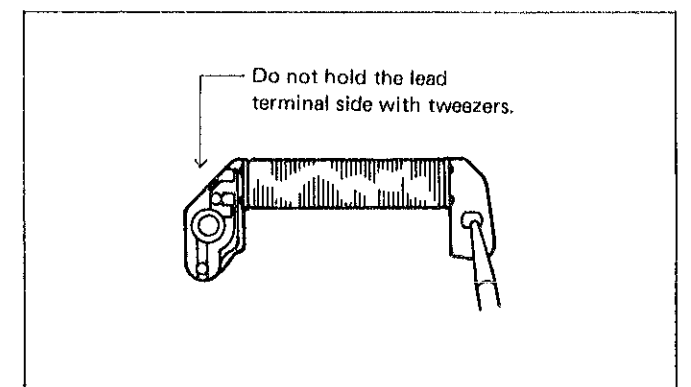

(4) Disassembling, reassembling and lubricating of the gear train mechanism

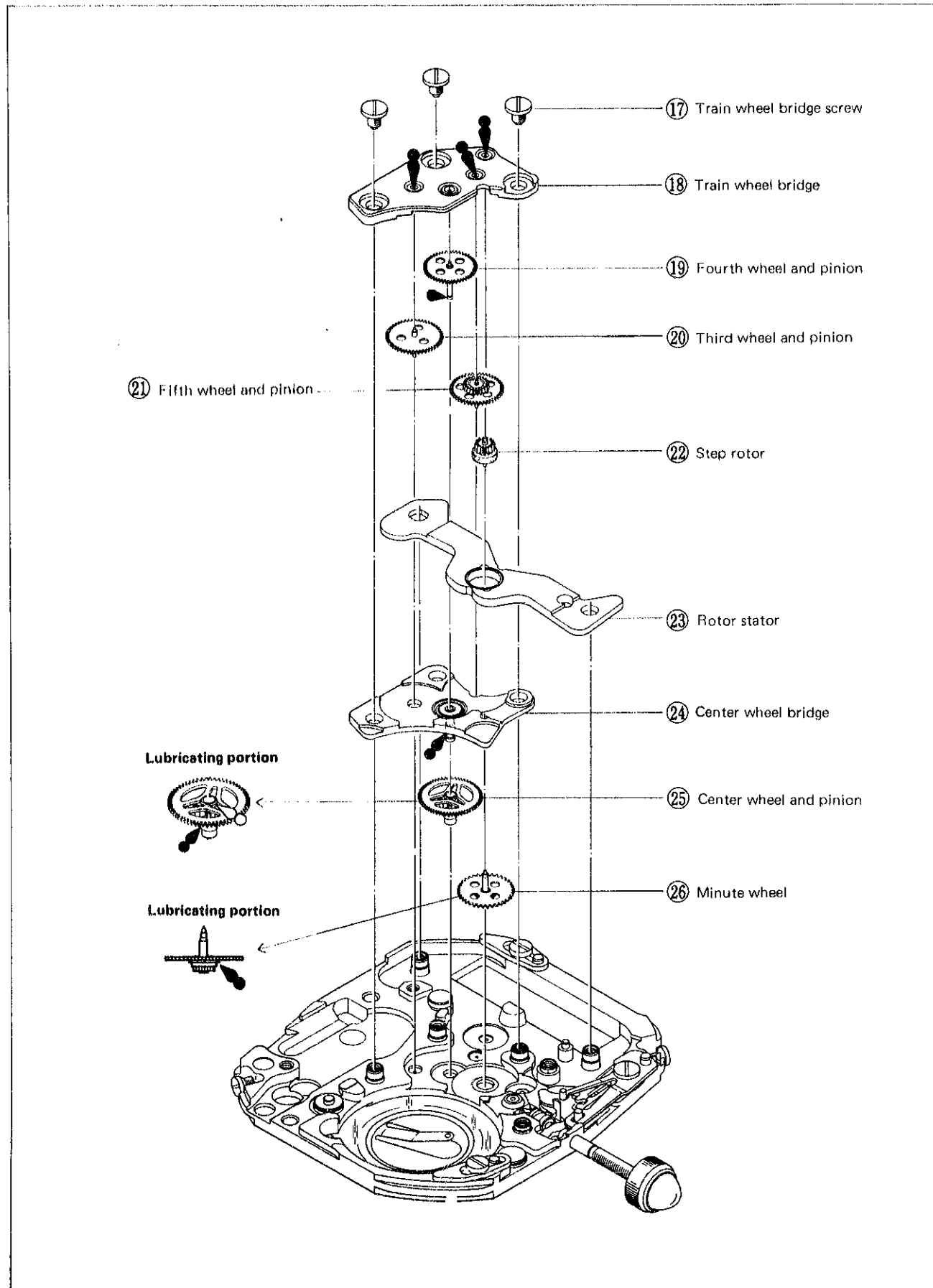

Remarks for disassembling and reassembling

22 Step rotor

Remarks for reassembling

- Check the clearances for the upper and lower pivots for the step rotor after tightening the screw for anti-magnetic shield plate.
- Use a microscope to check the clearances.

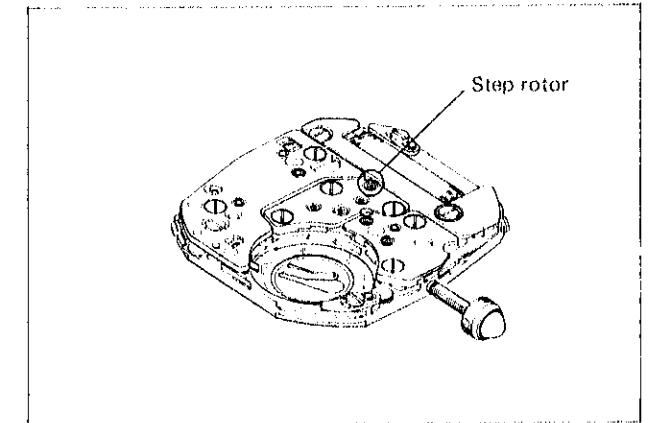

Check to see if the step rotor moves upward and downward from its standstill position by using a probe or pointed tweezers. Check the clearances while referring to the pivot diameter.

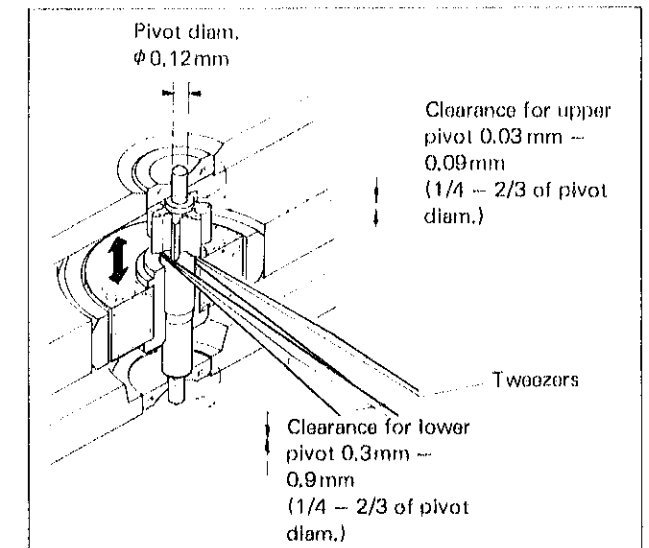

24 Center wheel bridge

Remarks for disassembling and reassembling

- As the axle is fixed into the center wheel bridge, be sure to handle the center wheel bridge horizontally so that it is not damaged.
- When disassembling the center wheel bridge, lift it slightly and turn the main plate upside down and then push the axle with tweezers. The center wheel bridge will be disassembled readily.

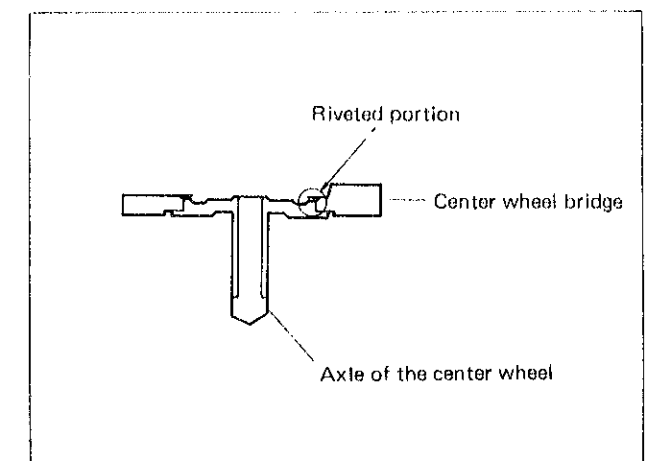

(5) Disassembling, reassembling and lubricating of the setting mechanism

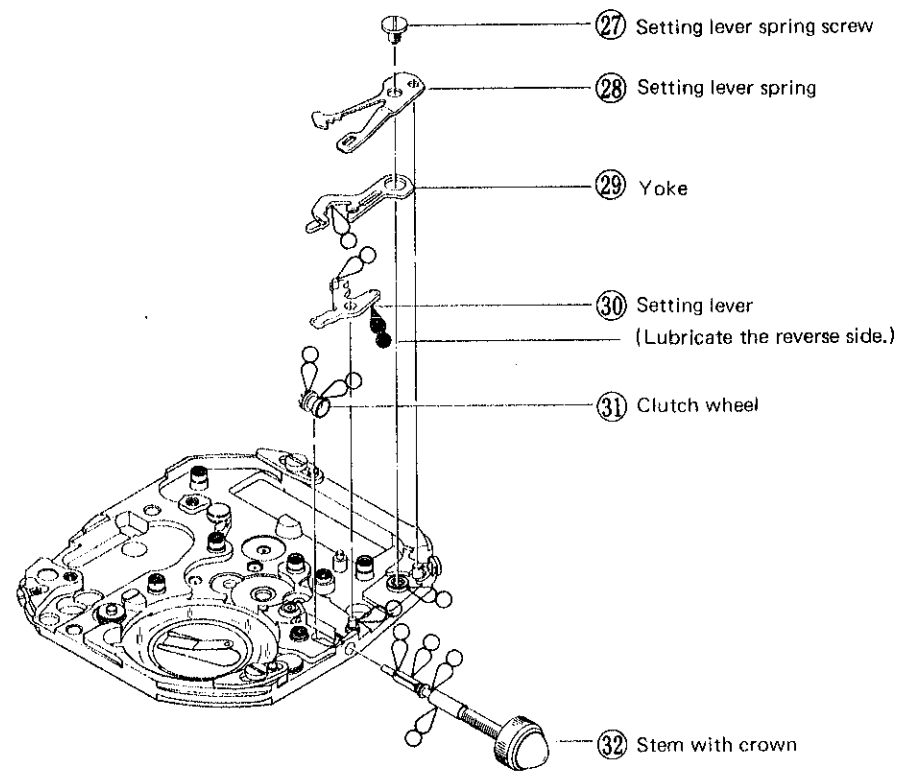

(Structural drawing of the setting mechanism)

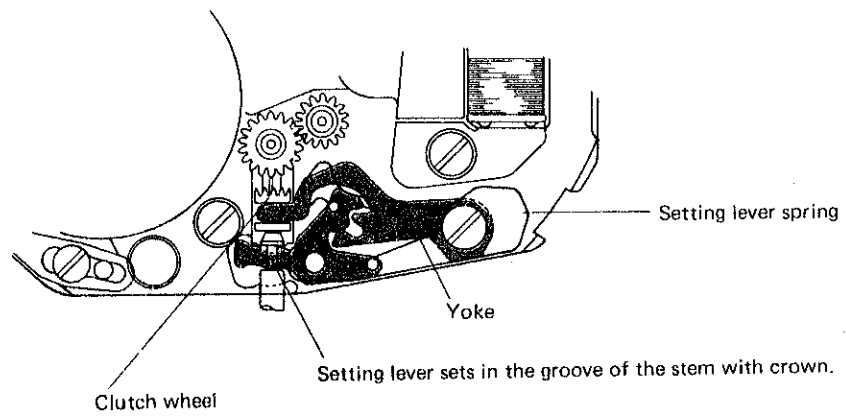



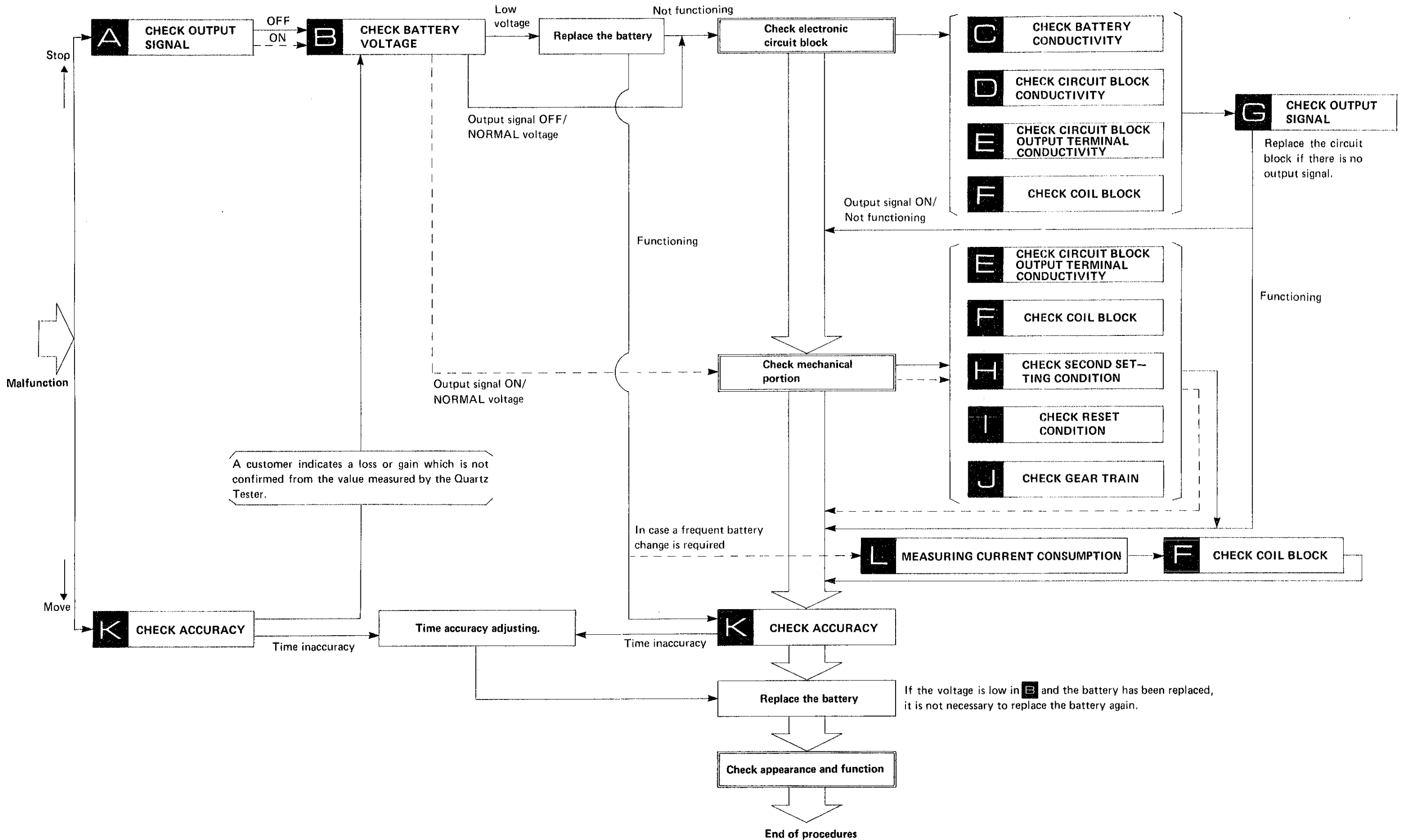

III. CHECKING AND ADJUSTMENT

1. Guide table for checking and adjustment

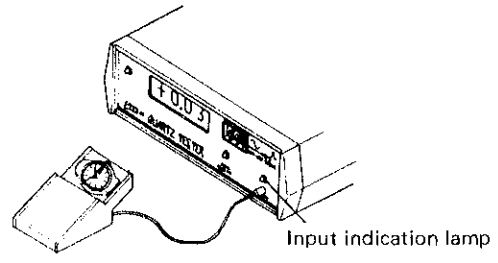
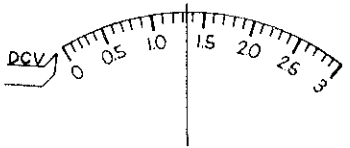
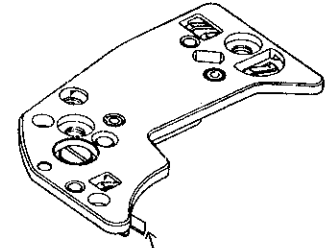

2. Procedures for checking and adjustment

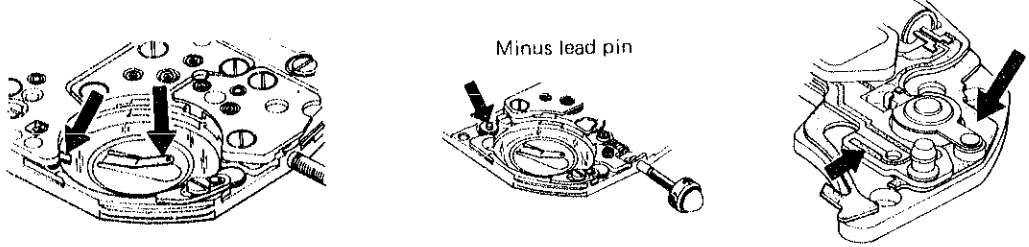
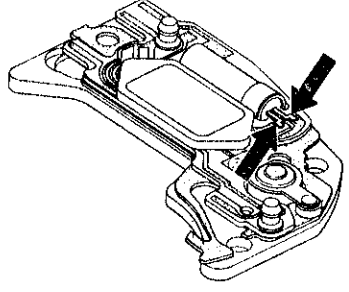
	Procedure	Result	Adjustment and Repair
CHECK OUTPUT SIGNAL	<p>Check for output signal.</p> <ol style="list-style-type: none"> 1. Set up the Quartz Tester. 2. Checking <p>Check for blinking input indication lamp. The input indication lamp blinks once every two seconds.</p>  <p>Note: Check with the crown in the normal position.</p>	<p>Two-second blinking — Normal</p> <p>No two-second blinking — Defective</p>	<p>Proceed to B.</p>
CHECK BATTERY VOLTAGE	<p>Check battery voltage.</p> <p>When there is battery electrolyte leakage, refer to "HOW TO CHECK BATTERY ELECTROLYTE LEAKAGE AND REPAIR" below for repairing.</p>	<p>More than 1.5V — Normal</p> <p>Less than 1.5V — Defective</p> 	<p>Proceed to Check mechanical portion if two-second blinking is found in A.</p> <p>Proceed to Check electronic circuit block if two-second blinking is not found in A.</p> <p>Proceed to Replace the battery.</p> <ul style="list-style-type: none"> • If the watch operates after battery replacement, proceed to I. • If the watch does not operate after battery replacement, proceed to Check electronic circuit block.
HOW TO CHECK BATTERY ELECTROLYTE LEAKAGE AND REPAIR	<ol style="list-style-type: none"> 1. Remove the movement from case. 2. Disassemble the movement. 3. Wipe off battery electrolyte on the circuit block. <ol style="list-style-type: none"> (1) Wipe off battery electrolyte with a cloth moistened with distilled water. (If distilled water is not available, use tap water.) (2) Wipe them with a cloth moistened with alcohol. (If the cleaned portions remain wet with water, they will corrode with rust.) (3) Dry with cool air by using a dryer.  <p>Be sure to wipe off battery electrolyte on the battery connection (+).</p>		<ol style="list-style-type: none"> 4. Clean battery electrolyte on the battery connection and other parts. 5. Reassemble the movement. (Replace the battery with a new one.) 6. Check to see if the setting functions and the current consumption are normal. <p>Note: If parts completely corroded with rust and cannot be corrected by cleaning, replace them with new ones.</p>

	Procedure		Result	Adjustment and Repair
C CHECK BATTERY CONDUCTIVITY	<p>Check to see if the battery current flow to the circuit block is normal.</p>  <p>Check for any contamination on the connecting portions of the battery, battery connection (+) and battery connection (-).</p> <p>Plus and minus lead terminal of circuit block</p> 		<p>Uncontaminated ----- Normal -----></p> <p>Contaminated ----- Defective -----></p>	<p>Proceed to D.</p> <ul style="list-style-type: none"> Wipe off any foreign matter. <p>Note: Be careful not to bend the battery connection (-) and the battery connection (+).</p>
D CHECK CIRCUIT BLOCK CONDUCTIVITY	<p>Check for defective conductivity of the conductive portions of the circuit block. Disassemble the circuit block and check conductivity of the arrow-marked portions by using a microscope.</p> 		<p>No defective conductivity ----- Normal -----></p> <p>Defective conductivity ----- Defective -----></p>	<p>Proceed to E.</p> <ul style="list-style-type: none"> Replace the circuit block with a new one.
E CHECK CIRCUIT BLOCK OUTPUT TERMINAL CONDUCTIVITY	<p>Disassemble the circuit block and check the connecting portions of the circuit block output terminal and the coil block. Check for any foreign matter on the circuit block output terminal and the coil lead terminal.</p> 		<p>Uncontaminated: ----- Normal -----></p> <p>Contaminated: ----- Defective -----></p>	<p>Proceed to F.</p> <ul style="list-style-type: none"> Wipe off any foreign matter.

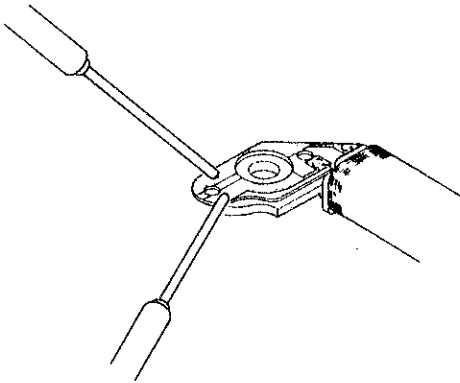
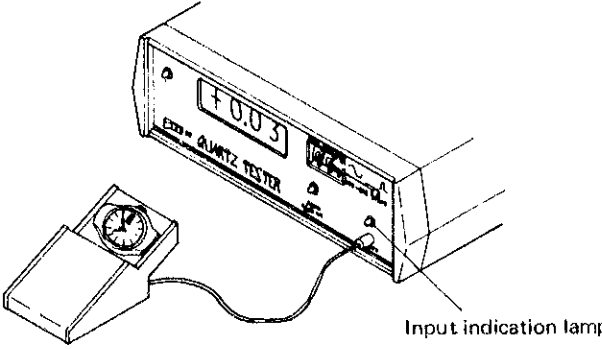
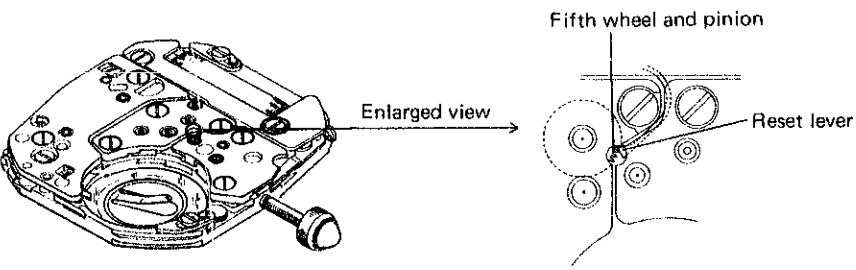
	Procedure		Result	Adjustment and Repair
7 CHECK COIL BLOCK	<p>Check for broken coil wire and short circuit of the coil block.</p> <ol style="list-style-type: none"> 1. Set up the Volt-ohm-meter. Range to be used: OHMS R x 100 2. Checking Apply the red and black probes of the Volt-ohm-meter to the two coil lead terminals. <p>Either red or black probe will do.</p> 		<p>1.5KΩ ~ 3.5KΩ — Normal</p> <p>More than 3.5KΩ — Broken coil wire</p> <p>Less than 1.5KΩ — Short-circuit</p>	<p>Proceed to 6 if the electronic circuit block must be checked. Proceed to 4 if the mechanical portion must be checked.</p> <ul style="list-style-type: none"> • Replace the coil block with a new one.
G CHECK OUTPUT SIGNAL	<p>Check for output signal.</p> <ol style="list-style-type: none"> 1. Set up the Quartz Tester. 2. Checking <p>Follow the same procedures as in A.</p> 		<p>Blinking — Functioning (Moves at ten-second intervals.)</p> <p>Not functioning</p> <p>No blinking — Defective</p>	<p>Proceed to K</p> <p>Proceed to Check mechanical portion 11.</p> <p>Replace the circuit block with a new one.</p>
I CHECK SECOND SETTING CONDITION	<p>Check to see if the second setting condition is normal. Check to see if there is clearance between the reset lever and the fifth wheel and pinion when the crown is in the normal position. Also, check to see if the reset lever touches the fifth wheel and pinion when the crown is in the first click position. (Check from right above by using a microscope.)</p>  <p>The reset lever may not get in between the cogs of the fifth wheel and pinion. However, this is not a malfunction.</p>		<p>Functions — Normal</p> <p>Does not function — Defective</p>	<p>Proceed to 1</p> <ul style="list-style-type: none"> • Correct the bend of the reset lever if there is any. If it is impossible to correct, replace the reset lever with a new one.

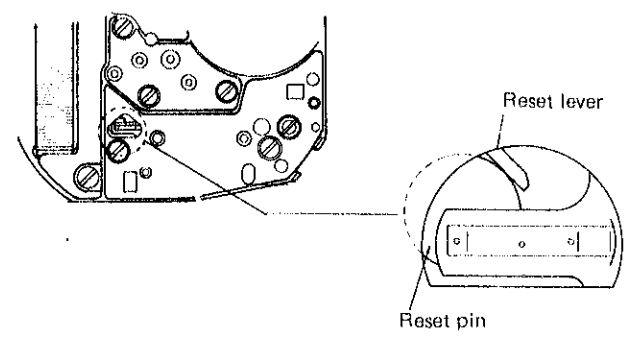
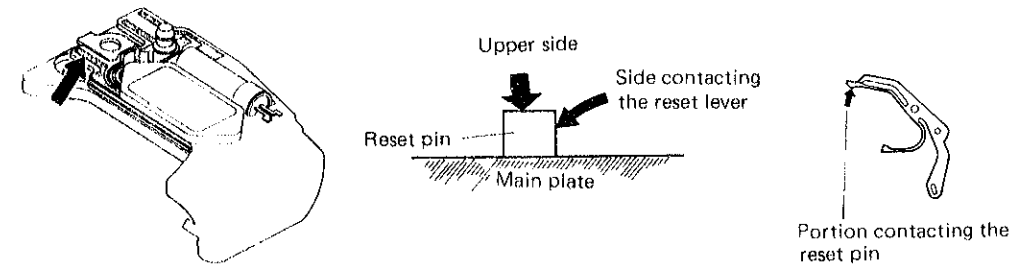
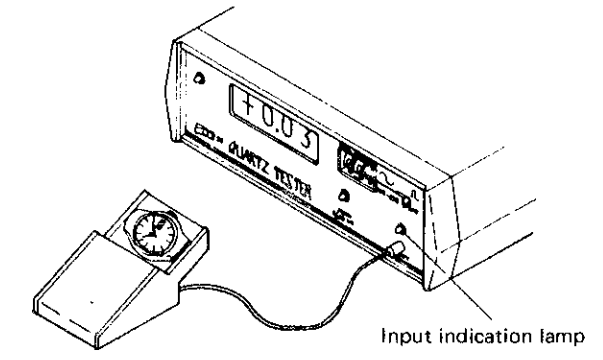
	Procedure		Result	Adjustment and Repair
CHECK RESET CONDITION	<p>Check the reset condition after the circuit block and the battery are reassembled.</p> <ol style="list-style-type: none"> 1. Check to see if the step rotor stops when the crown is pulled out completely (Watch for more than 10 seconds to check if it stopped) and if it starts promptly ten seconds after the crown is pushed in to the normal position. 2. Check to see if the reset lever touches the reset pin when the crown is pulled out completely.  <p>Reset lever Reset pin</p> <ol style="list-style-type: none"> 3. Check for any contamination on the connecting positions of the reset lever and the reset terminal of the circuit.  <p>Upper side Side contacting the reset lever Reset pin Main plate Portion contacting the reset pin</p>		<p>Stops completely and starts moving after ten seconds — Normal —→</p> <p>Does not stop or moves irregularly — Defective —→</p> <p>Reset lever touches the reset pin — Normal —→</p> <p>Reset lever does not touch the reset pin — Defective —→</p> <p>Uncontaminated: — Normal —→</p> <p>Contaminated: — Defective —→</p>	<p>Proceed to J.</p> <p>Proceed to I 2.</p> <p>Proceed to I 3.</p> <ul style="list-style-type: none"> • The reset lever is bent or not reassembled correctly. If the reset lever is bent, correct the bend or replace it with a new one. And then follow the procedures in I 1. <p>Proceed to J.</p> <ul style="list-style-type: none"> • Wipe the connecting portions of the circuit block with a cloth moistened with benzine. • Rinse the reset pin and the reset lever with benzine. <p>And then follow the procedures in I 1.</p>
CHECK GEAR TRAIN	<p>Check the gear train for the following points.</p> <ol style="list-style-type: none"> 1. Check for dust, lint and filings. 2. Check for oil condition (quantity, deterioration, etc.) 3. Check for clearance. 		<p>Normal —→</p> <p>Defective —→</p>	<ul style="list-style-type: none"> • Replace the circuit block with a new one. • Correct the defective portions. (Remove dust, lint and filings, relubricate or adjust clearances.) <p>If it functions correctly after following the above procedures, proceed to K.</p>
CHECK ACCURACY	<p>Check gain and loss of time.</p> <ol style="list-style-type: none"> 1. Set up the Quartz Tester. 2. Checking <p>Follow the same procedures as in M.</p>  <p>Input indication lamp</p>		<p>Normal —→</p> <p>Defective —→</p>	<p>Follow the procedures in "Guide table for checking and adjustment" on page 11.</p> <p>Refer to Measuring daily rate on page 2.</p>

Procedure

In case a frequent battery change is required, a current consumption test is recommended. Measure the current consumption with the Volt-ohm-meter of as small a range as possible ($12\mu\text{A}$ or less). The measurement with the SEIKO Volt-ohm-meter S-831 is described below.

Procedures

1. Set up the Volt-ohm-meter.
Range to be used: DC $12\mu\text{A}$
 - Set up the condenser of $200\text{--}500\mu\text{F}$ as shown in the photo.
 2. Set the watch.
 - Place the battery on the train wheel bridge on its minus side up.
 3. Measurement
 - Probe Red (+) . . . Battery connection (-)
 - Probe Black (-) . . . Battery surface (-)
- Note:** Be sure to measure with the crown pushed in.

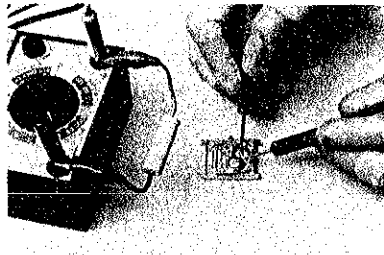

If the pointer of the Volt-ohm-meter scales out, reset the rotary step switch to DC 30 mA and then return to DC $12\mu\text{A}$ while applying the probes.

Note: Cal. 6020A moves at 10-second intervals. In order to get a stable reading, continue to measure for 2 to 3 minutes.

Remarks: If the Current Supplier (S-833) is used instead of placing the battery on the train wheel bridge, a more accurate measurement will be taken. (See the instruction manual for the Current Supplier S-833.)

Result

Adjustment and Repair

- Less than $0.8\mu\text{A}$ — Normal —————> The current consumption is normal.
- More than $0.8\mu\text{A}$ — Defective —————> Replace the circuit block or coil block with a new one.

All procedures of Disassembling, Reassembling, Checking and Adjustment are completed.