

**LASSALE
SEIKO**

QUARTZ

Cal. 5A50A, 5A54A

**PARTS
CATALOGUE**

Cal. 5A50A, 5A54A



☆ 125 881



☆ 221 881



231 881



241 881



261 930



☆ 271 930



282 881



☆ 354 881



383 881



384 881



388 881



491 930



494 881



494 882



494 883



839 881



4001 550



4002 550



4146 550



4216 550



4216 551



4225 550



4239 550



4270 550



4408 550



4457 550



4531 550



Maxell SR512SW



022 241



022 411

3/4

Cal. 5A50A, 5A54A

Characteristics

	Cal. 5A50A	Cal. 5A54A
Casing diameter	15.6 × 9.5 mm	19.0 × 18.0 × 16.0 mm
Maximum height	1.3 mm	
Frequency of quartz crystal oscillator	32,768 Hz (Hz = Hertz Cycles per second)	
Driving system	Step motor (2 poles)	
Reguration system	—	
Train wheel setting	—	

PART NO.	PART NAME	PART NO.	PART NAME
☆125 881	Train wheel bridge	027 771	Minute wheel pin
☆221 881	Center wheel & pinion	027 788	Guide pin for rotor stator
231 881	Third wheel & pinion	027 789	Setting lever pin
241 881	Fourth wheel & pinion	☆Maxell SR512SW	Silver Oxide Battery
261 930	Minute wheel	☆SEIKO SR512SW	Silver (II) Oxide battery
☆271 930	Hour wheel		
282 881	Clutch wheel		
☆354 881	Winding stem (Cal. 5A50A)		
☆354 882	Winding stem (Cal. 5A54A)		
383 881	Setting lever		
384 881	Yoke		
388 881	Setting lever spring		
491 930	Dial washer		
494 881	Dial stopper (Cal. 5A50A)		
494 882	Dial stopper (Cal. 5A54A)		
494 883	Center wheel & pinion spring (Cal. 5A54A)		
839 881	Spacer (Cal. 5A54A)		
4001 550	Circuit block		
4002 550	Coil block		
4146 550	Step rotor		
4216 550	Insulator for battery (A)		
4216 551	Insulator for battery (B)		
4225 550	Battery clamp		
4239 550	Rotor stator		
4270 550	Battery connection (—)		
4408 550	Circuit block spacer		
4457 550	Circuit block cover (Cal. 5A50A)		
4457 551	Circuit block cover (Cal. 5A54A)		
4531 550	IC cover		
011 425	Upper hole jewel for third wheel		
011 425	Upper hole jewel for fourth wheel		
011 542	Lower hole jewel for third wheel		
011 542	Lower hole jewel for fourth wheel		
011 547	Upper hole jewel for step rotor		
011 582	Lower hole jewel for step rotor		
022 241	Train wheel bridge screw		
022 241	Circuit block cover screw		
022 241	Battery clamp screw		
022 241	Setting lever spring screw		
022 241	Spacer screw (Cal. 5A54A)		
022 411	Coil block screw		
☆027 185	Tube for train wheel bridge (A)		
☆027 186	Tube for train wheel bridge (B)		
027 186	Tube for setting lever spring		
027 186	Tube for spacer		
027 755	Setting lever spring pin		
027 755	Yoke pin		

☆ ⇨ Please see remarks on the reverse page.
Part numbers in light letters are not shown in photos.

Cal. 5A50A, 5A54A

Remarks :

Train wheel bridge, Center wheel & pinion, Hour wheel

There are four different types as specified below.

Combination :

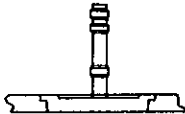
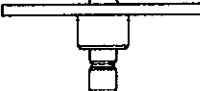
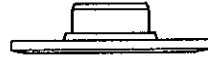
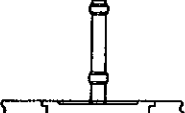
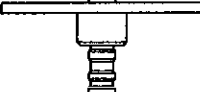
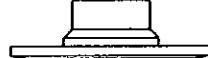
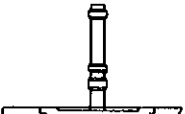
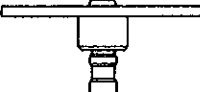
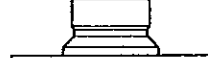
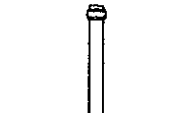
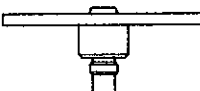
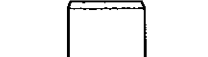
Type	Train wheel bridge	Center wheel & pinion	Hour wheel
a	 ☆125 882	 ☆221 882	 ☆271 882
b	 ☆125 881	 ☆221 881	 ☆271 930
c	 ☆125 880	 ☆221 883	 ☆271 883
d	 ☆125 884	 ☆221 884	 ☆271 931

Tube for train wheel bridge (A), (B)

☆027 185 }Refer to the illustration.
☆027 186 }



Winding stem

☆354 881 (Cal. 5A50A) }Refer to the photograph on the front page.
☆354 882 (Cal. 5A54A) }

If the combination of the winding stem and case is unknown, check the case number and refer to "SEIKO Quartz Casing Parts Catalogue" to choose a corresponding winding stem.

TECHNICAL GUIDE

LASSALE SEIKO

QUARTZ

CAL. 5A50A

CAL. 5A54A



CONTENTS

I. SPECIFICATIONS	1
II. STRUCTURE OF THE CIRCUIT BLOCK	1
III. DISASSEMBLING, REASSEMBLING, AND LUBRICATING	2
1. Hour and minute hands ~ Minute wheel	2
Cal. 5A50A	
2. Battery ~ Battery connection insulator B	3
3. Train wheel bridge screw ~ Main plate	4
Cal. 5A54A	
2. Spacer screw ~ Battery connection insulator B	5
3. Train wheel bridge screw ~ Main plate	6
• Remarks on installing the battery	7
IV. CHECKING AND ADJUSTMENT	8
• Check output signal	8
• Check battery voltage	8
• Check coil block	8
• Check reset condition	8
• Check accuracy	9
• Check current consumption	9

I. SPECIFICATIONS

Cal. No.		5A50A	5A54A
Item			
Time indication		2 hands	
Driving system		Step motor	
Loss/gain		Monthly rate at normal temperature range: less than 15 seconds	
Additional mechanism		Electronic circuit reset switch	
Movement size	Outside diameter	ϕ 16.0 mm 9.5 mm between 3 o'clock and 9 o'clock sides	ϕ 20.0 mm 18.0 mm between 6 o'clock and 12 o'clock sides 16.0 mm between 3 o'clock and 9 o'clock sides
	Casing diameter	ϕ 15.6 mm 9.5 mm between 3 o'clock and 9 o'clock sides	ϕ 19.0 mm 18.0 mm between 6 o'clock and 12 o'clock sides 16.0 mm between 3 o'clock and 9 o'clock sides
	Height	1.3 mm	
Regulation system		Regulating switch lever (Pattern cutting system)	
Measuring gate by quartz tester		Use the 10-second gate.	
Battery		SEIKO (SEIZAIKEN) SR512SW, Maxell SR512SW Battery life is approximately 2 years. Voltage: 1.55V	
Jewels		6 jewels	

II. STRUCTURE OF THE CIRCUIT BLOCK

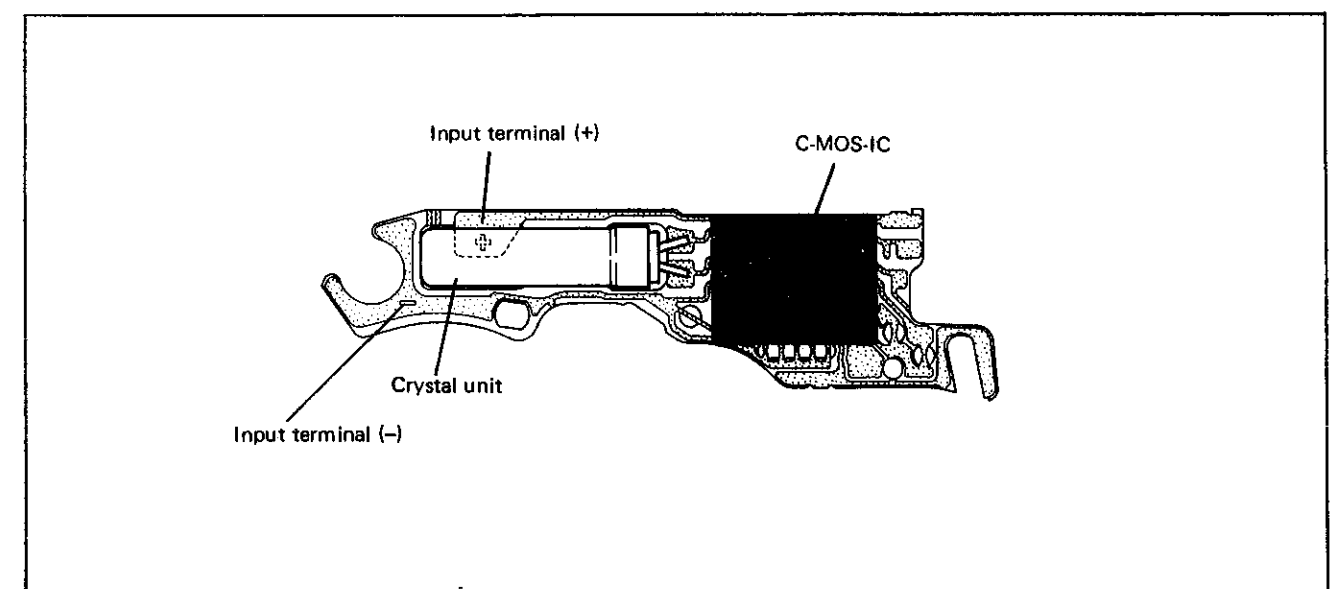

III. DISASSEMBLING, REASSEMBLING, AND LUBRICATING

List of the screws used

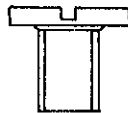
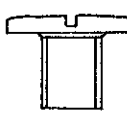
Shape	Part No.	Name	Shape	Part No.	Name
	022 241	Train wheel bridge screw Circuit block cover screw Spacer screw Battery clamp screw Setting lever spring screw		022 411	Coil block screw

Disassembling procedures Figs. : ① → ⑤

Reassembling procedures Figs. : ⑤ → ①

Lubricating:  Moebius A
Normal quantity

1. Hour and minute hands ~ Minute wheel

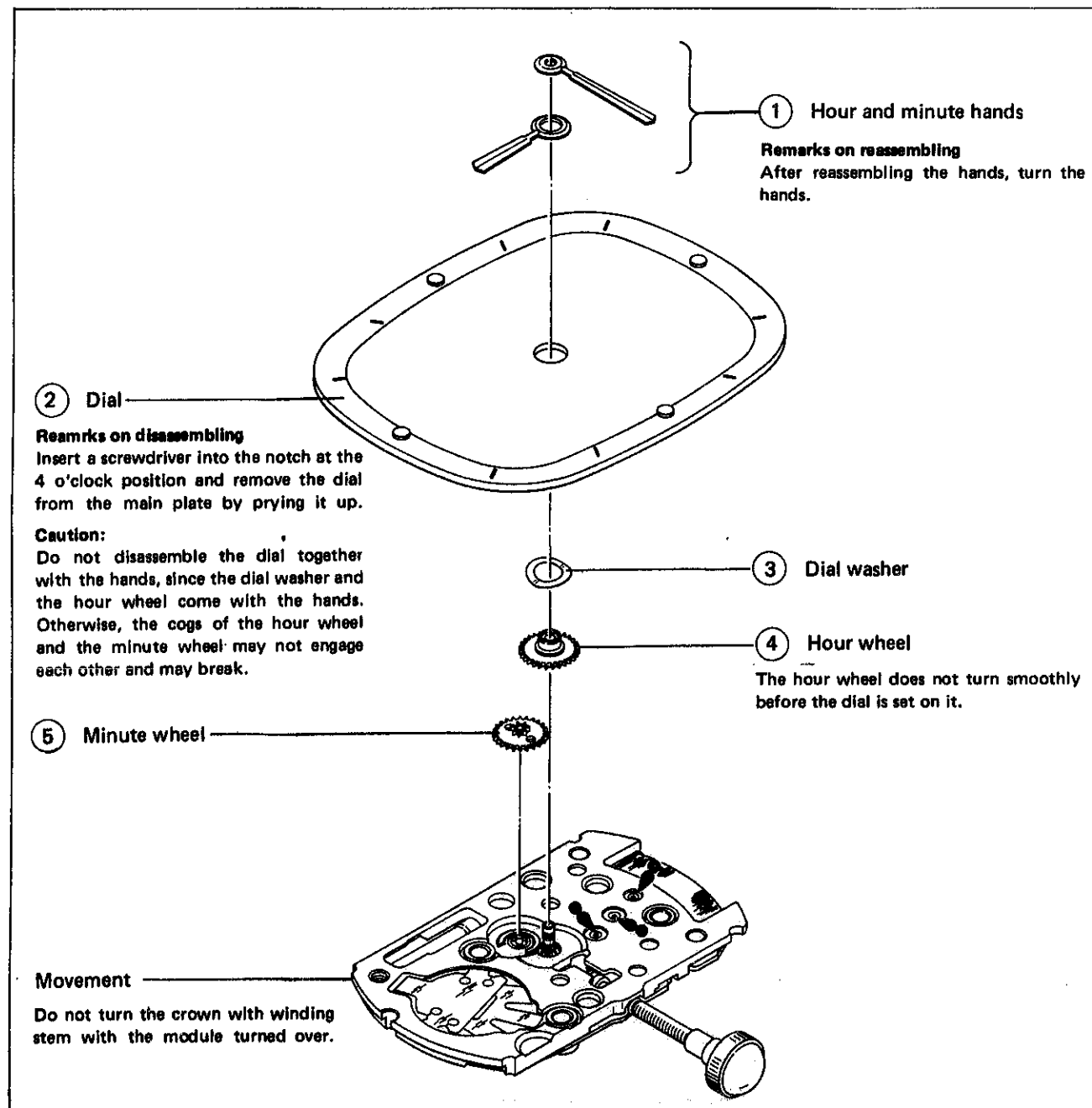

Cal. 5A50A

Disassembling procedures Figs. : ① → ②⑧

Reassembling procedures Figs. : ②⑧ → ①

Lubricating:  Moebius A
Normal quantity

2. Battery ~ Battery connection insulator B

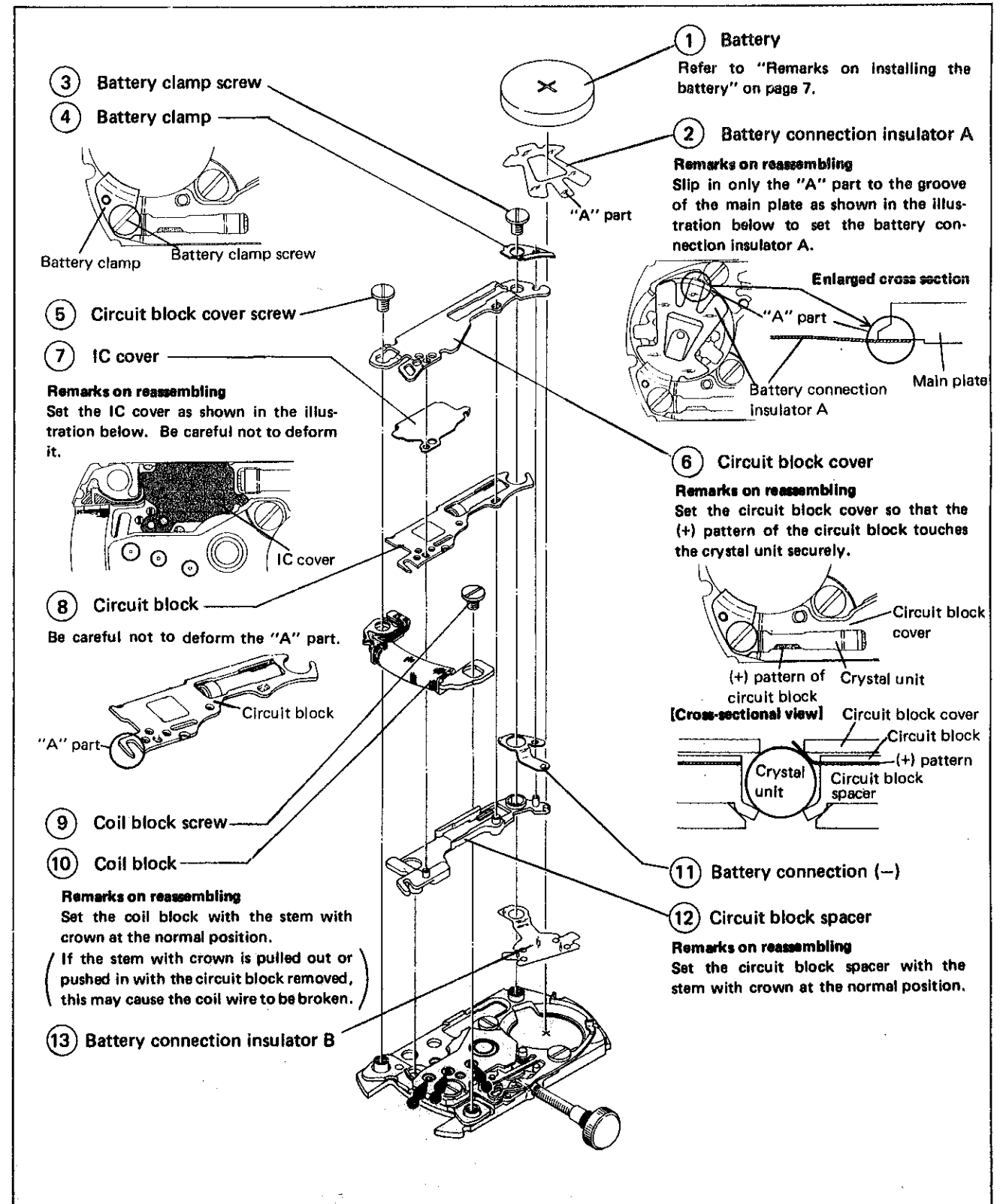

3. Train wheel bridge screw ~ Main plate

Lubricating:  Moebius A
Normal quantity

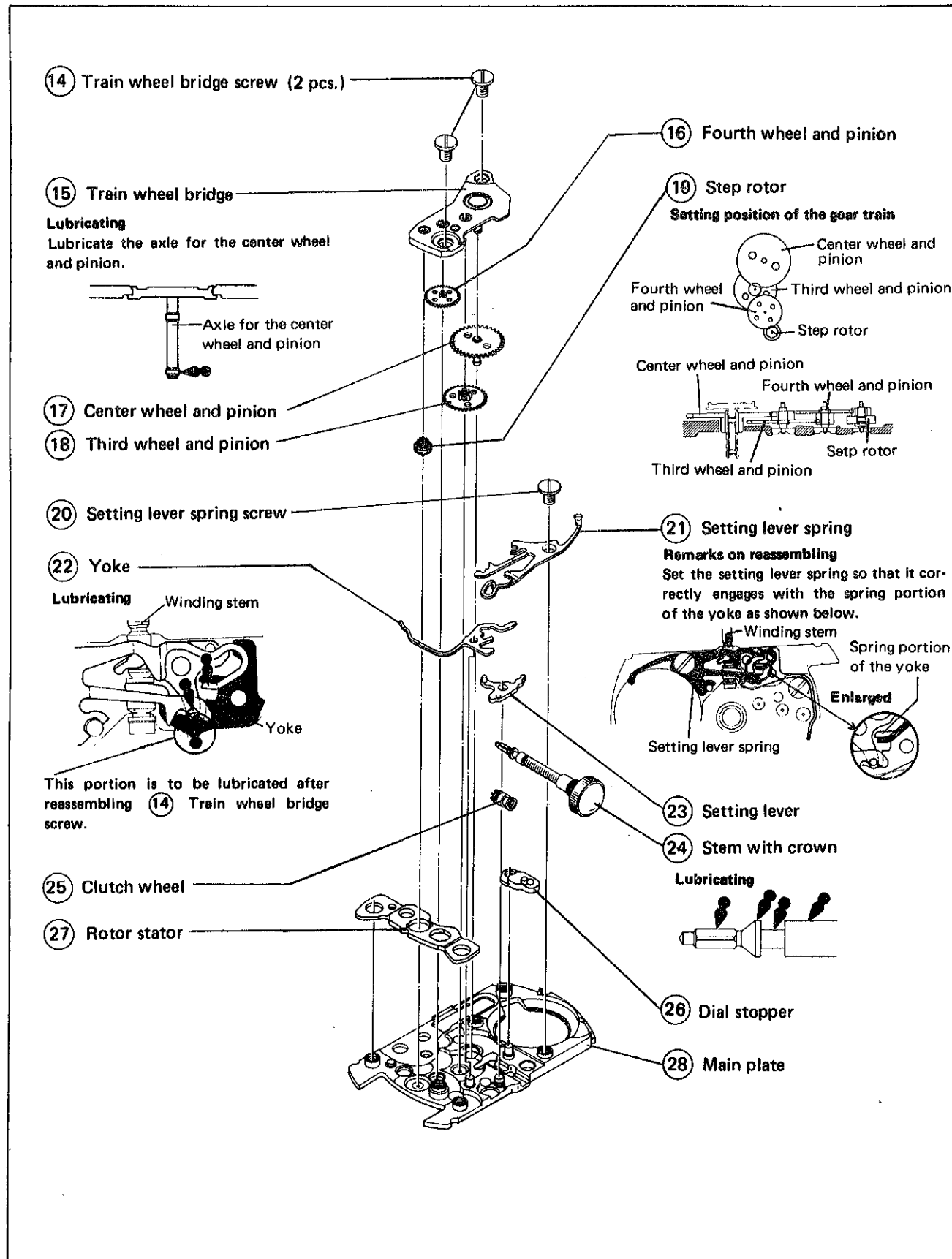

Cal. 5A54A

Disassembling procedures Figs. : **1** → **31**

Reassembling procedures Figs. : **31** → **1**

Lubricating:  Moebius A
Normal quantity

2. Spacer screw ~ Battery connection insulator B

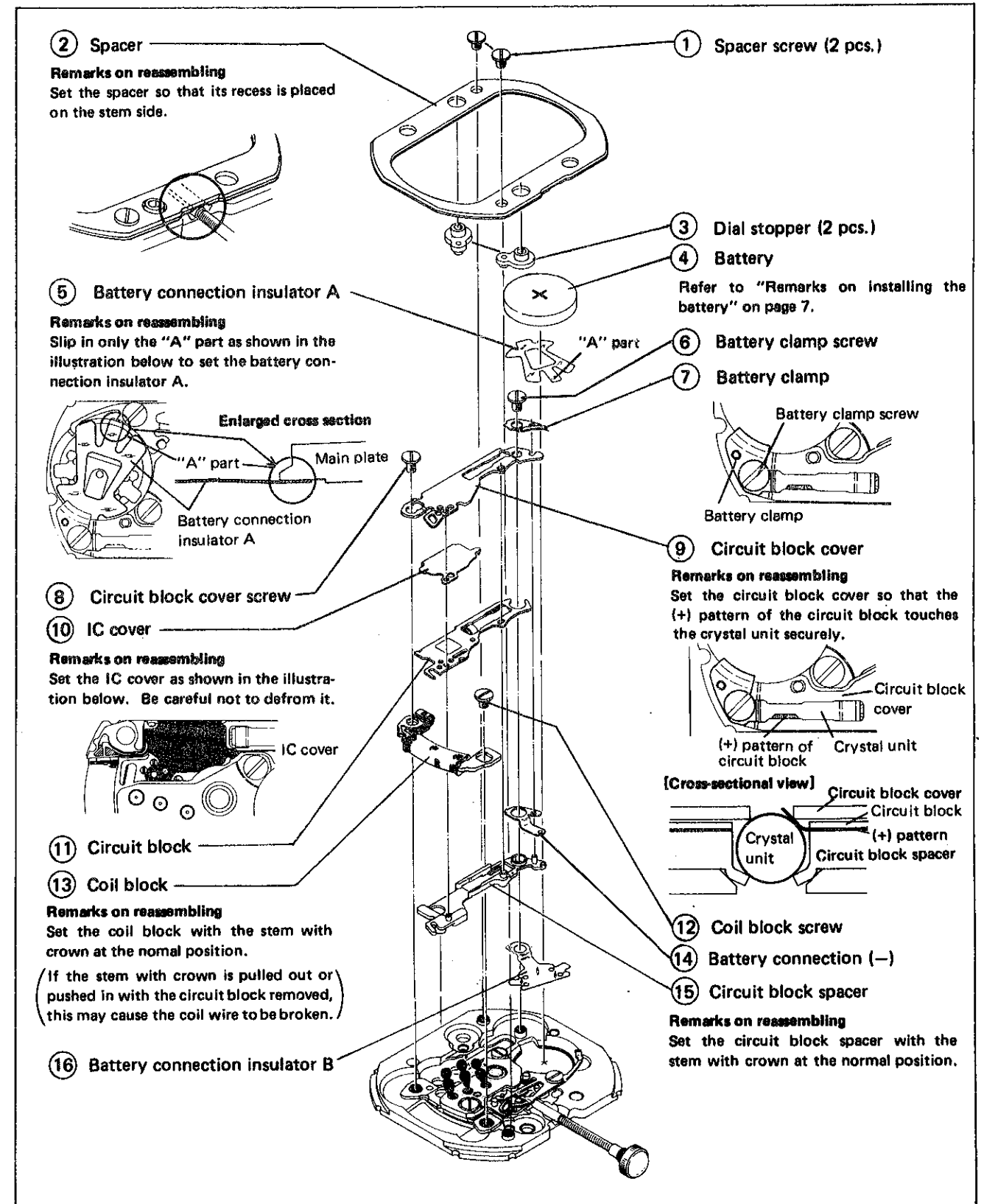

3. Train wheel bridge screw ~ Main plate

Lubricating:  Moebius A
Normal quantity

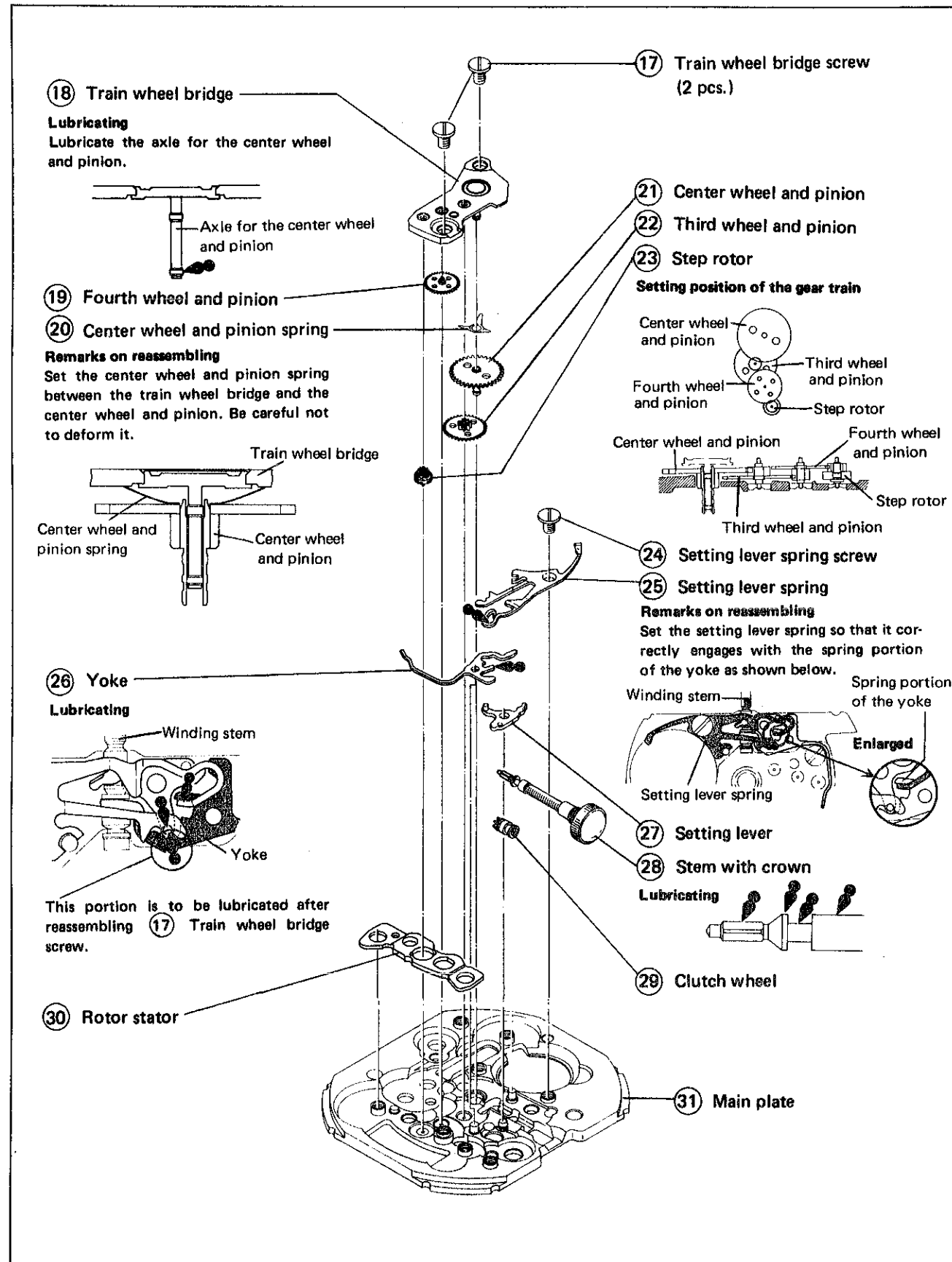

• Remarks on installing the battery

Notes:

1. Before installing the battery, be sure to check that the battery connection insulator A is set correctly.
2. It is not necessary to remove the battery clamp when replacing the battery.

- Install the battery under the battery clamp.

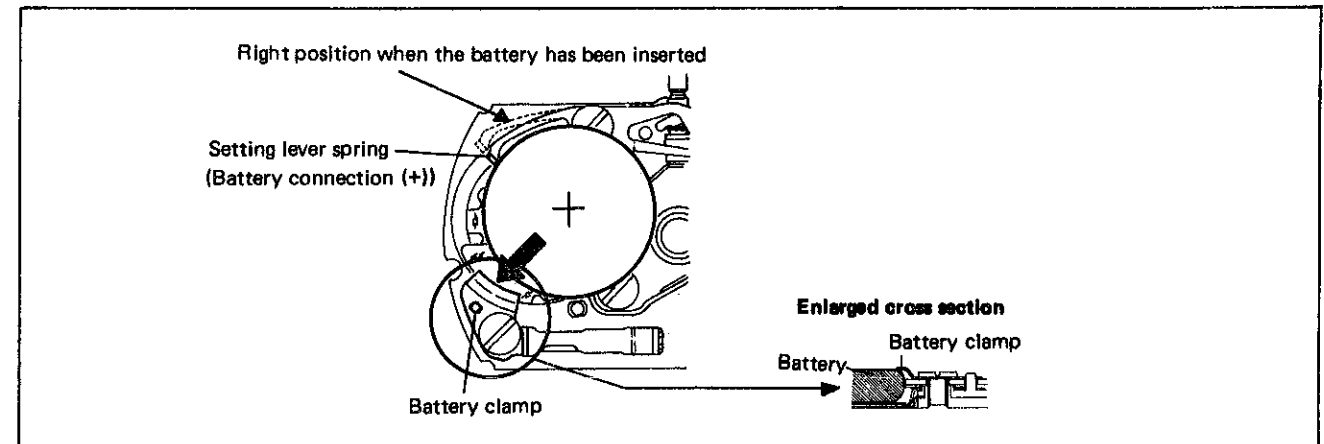

- Set the setting lever spring (battery connection (+)) so that it touches the battery surface as shown in the illustration on the right.

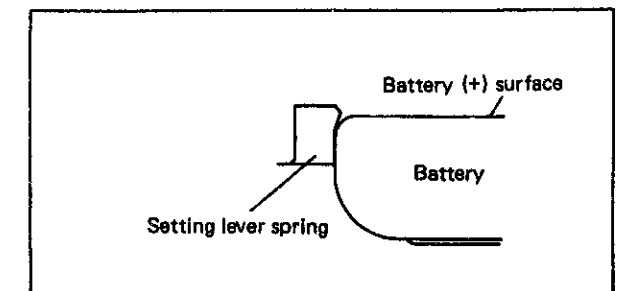

IV. CHECKING AND ADJUSTMENT

- The explanation here is only for the particular points of Cals. 5A50A and 5A54A. Refer to the "TECHNICAL GUIDE, GENERAL INSTRUCTION" for SEIKO Analogue Quartz for details.

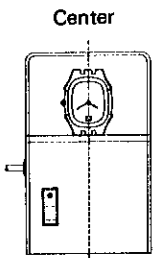
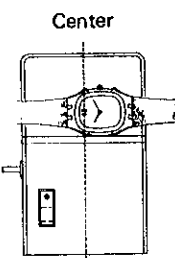
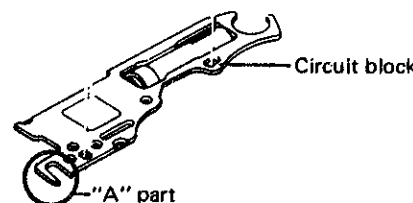
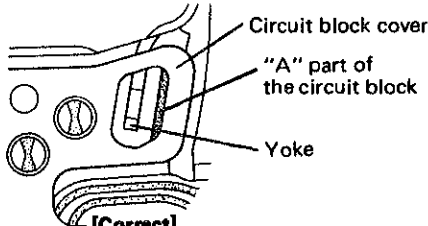
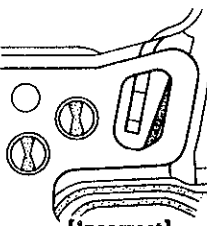
Procedure	
<div style="border: 1px solid black; padding: 2px; margin-bottom: 10px;">CHECK OUTPUT SIGNAL</div> <p>Use the quartz tester. Range to be used: 10-second gate</p> <p>Place the watch on the microphone in either way as shown in the illustrations below so that the quartz tester can measure output signal correctly.</p> <div style="display: flex; justify-content: space-around; margin-top: 10px;"> <div style="text-align: center;"> <p>— Watch complete —</p>  <p>Center</p> <p>Set the watch with the 12 o'clock side down.</p> </div> <div style="text-align: center;"> <p>— Watch with bracelet —</p>  <p>Center</p> <p>Place the watch with the crown side up and set it rightward.</p> </div> </div>	
<div style="border: 1px solid black; padding: 2px; margin-bottom: 10px;">CHECK BATTERY VOLTAGE</div> <p>Use the Digital Multi-Tester. Range to be used: DC V</p>	<p>Result: Normal : More than 1.57V Defective : Less than 1.57V</p>
<div style="border: 1px solid black; padding: 2px; margin-bottom: 10px;">CHECK COIL BLOCK</div> <p>Use the Digital Multi-Tester. Range to be used: Ω</p>	<p>Result: Normal : $1.8K\Omega \sim 2.6K\Omega$ Defective — More than $2.6K\Omega$ Less than $1.8K\Omega$</p>
<div style="border: 1px solid black; padding: 2px; margin-bottom: 10px;">CHECK RESET CONDITION</div> <ol style="list-style-type: none"> Pull the crown out completely, and release your hand. Then, check to see that the minute hand moves 20 seconds after the crown is pushed in. Push in the crown to the normal position. <ul style="list-style-type: none"> Check to see that the "A" part of the circuit block is set parallel to the circuit block cover. Check to see that there is some clearance between the yoke and the "A" part of the circuit block. <div style="display: flex; justify-content: space-around; margin-top: 10px;"> <div style="text-align: center;">  <p>Circuit block</p> <p>"A" part</p> </div> <div style="text-align: center;">  <p>Circuit block cover</p> <p>"A" part of the circuit block</p> <p>Yoke</p> <p>[Correct]</p> <p>The "A" part of the circuit block is set parallel to the circuit block cover.</p> </div> <div style="text-align: center;">  <p>[Incorrect]</p> <p>Not parallel</p> </div> </div>	

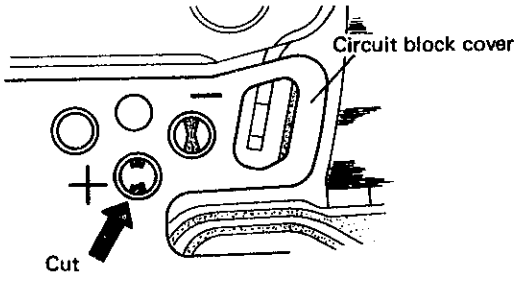
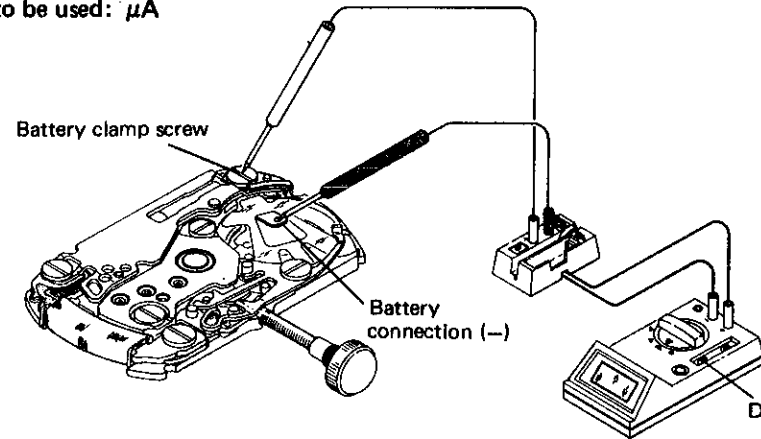
Procedure	
<ol style="list-style-type: none"> Pull out the crown completely. Check to see that the yoke touches the "A" part of the circuit block. 	
<div style="border: 1px solid black; padding: 2px; margin-bottom: 10px;">CHECK ACCURACY</div> <p>Measuring time accuracy</p> <ul style="list-style-type: none"> Use the 10-second gate of the quartz tester. Place the watch on the microphone in such a way as described in "CHECK OUTPUT SIGNAL" on page 8. Do not measure accuracy under an incandescent lamp, since strong light adversely affects time accuracy. Be sure to protect the movement from light with case back or black paper. <p>Adjusting time accuracy</p> <ol style="list-style-type: none"> Confirm the appropriate pattern to be cut over the circuit block cover. (-) pattern : to lose approximately 0.26 sec./day (+) pattern : to gain approximately 0.26 sec./day Take off the circuit block cover. Cut the pattern. Remove the sludge completely. 	<p>Ex.: The illustration below shows that the (+) pattern is cut to gain time.</p>  <p>Circuit block cover</p> <p>Cut</p>
<div style="border: 1px solid black; padding: 2px; margin-bottom: 10px;">CHECK CURRENT CONSUMPTION</div> <p>Be sure to protect the movement from light with black paper while measuring. Do not check current consumption under an incandescent lamp, since strong light may cause a watch to consume excess current.</p> <p>Use the Digital Multi-Tester. Range to be used: μA</p>	<p>Result: Normal : Less than $0.3\mu A$ Defective : More than $0.3\mu A$</p>
 <p>Battery clamp screw</p> <p>Battery connection (-)</p> <p>Display stabilizing switch</p>	
<p>Measuring current consumption</p> <ol style="list-style-type: none"> Set the display stabilizing switch of the tester to the "B" position. Apply the (+) and (-) probes of the tester as shown in the illustration above. The tester displays a value, indicating that electric current is flowing in the IC. The value displayed is increased, since the current for driving the step motor flows once every 20 seconds. After approximately one minute, read a maximum value which is displayed stably. 	

All procedures of Disassembling, Reassembling, Lubricating, Checking and Adjustment are completed.