

***TECHNICAL
INFORMATION***

**CITIZEN QUARTZ
Cal.No.73※※※**

1. OUTLINE



The Citizen Quartz 73-series watches are thin-type analog quartz crystal watches for gentlemen. They feature a high accuracy as well as versatile functions to meet well diversified specifications.

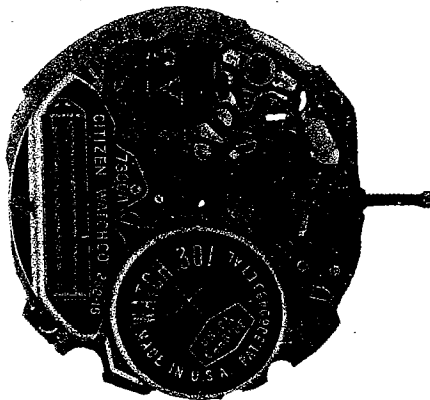

Movement
(Oscillator side)

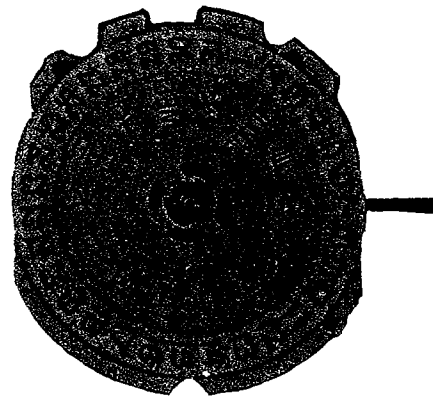

Movement
(Dial side)

2. MAIN FEATURES

1) Thin-type analog quartz crystal watch

The movement has been completed very thin owing to a highly efficient system of constitution for the circuit block, coil unit, power cell and the mechanical part.

2) Long power cell life of about 5 years

The life of a silver oxide power cell has been extended up to about 5 years owing to a low power consumption realized by an extreme improvement of the efficiency for the electronic circuit and the step motor.

3) Second-hand stopping device for accurate time setting

With the crown pulled out at the time-set position, the second-hand stops at an optional position. Thus, the time can be set accurately down to a second.

4) Power-saving switch

The power-saving switch operates when the crown is pulled out at the time-set position in order to extend the life of the power cell.

5) Warning device for power cell replacement

When the power cell life comes near its end, the usual 1-second step movement of the second-hand changes to the 2-second step movement, indicating the replacement of the power cell. The time is kept accurately as usual even in the case of the 2-second step movement.

6) Easy disassembly/assembly and troubleshooting of movement

Owing to a reduction of the number of the component parts, the disassembly/assembly and troubleshooting are much facilitated for the movement.

3. HANDLING INSTRUCTIONS

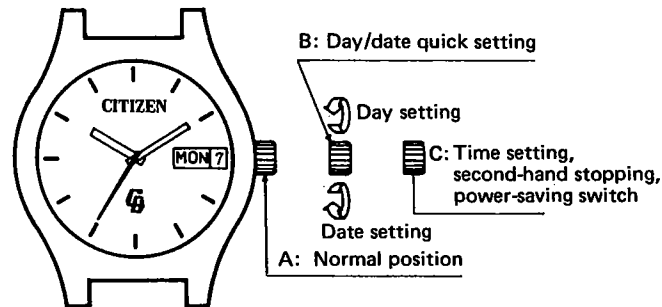

(The explanation of the drawing is of 7300A)

1) Time setting

Pull out the crown up to C-position and turn it to move the hands. Thus you can set a correct time, making sure AM and PM. If the date changes at 12 o'clock, it indicates 12 midnight.

2) Push the crown lightly.

The watch starts again.

3) Day/date setting

Turn the crown counterclockwise at B-position to change the date, and clockwise to change the day respectively. The day is displayed bilingually (Japanese and English alternately), so choose either one language. The selected language is displayed continuously thereafter.

4) Push in the crown up to A-position.

The day and date change automatically while using the watch.

4. STRUCTURE AND FUNCTION

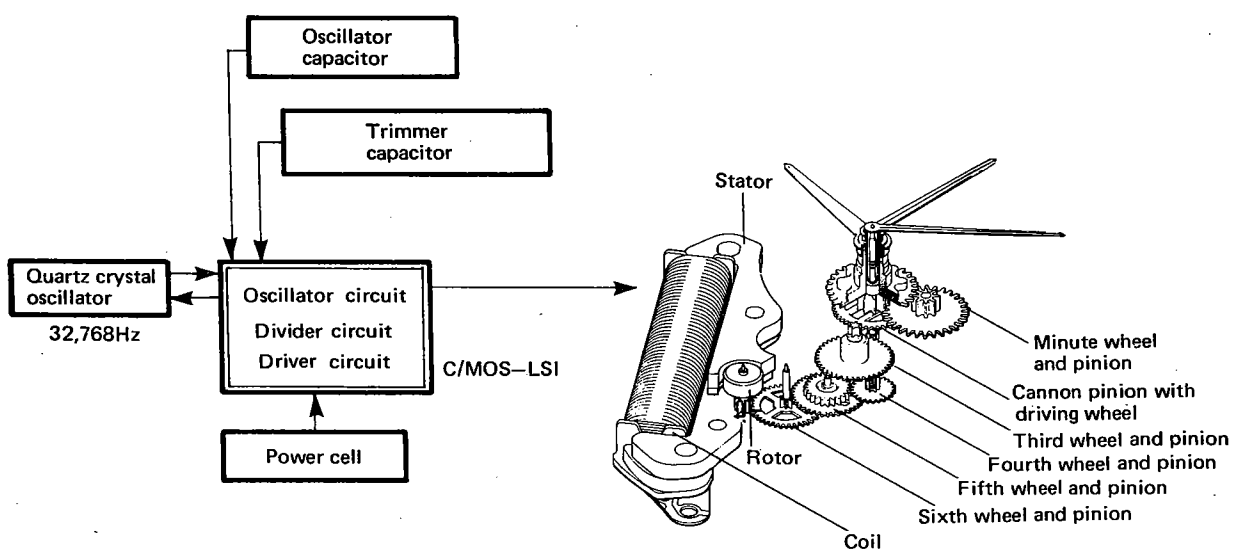

1) Driving mechanism

A highly stable oscillation of 32,768Hz, produced by a quartz crystal oscillator, is divided down to 1Hz through the divider circuit.

The pulse thus divided to 1Hz is amplified up enough to actuate the rotor through the driver circuit. At the same time, the pulse is converted to change to plus and minus alternately with every second.

In the case of Cal. No. 7300A, the efficiency of the electronic circuit and the step motor has been enhanced extremely and can be driven with a smaller pulse duration than conventional, thus realizing a reduced power consumption. With this pulse, the step motor is actuated. The step motor consists of the driving coil, stator and rotor.

The rotor is made of a permanent magnet of Sm-Co (samarium cobalt), and two poles (a pair) are magnetized at the outer circumference. The stator, underwent a stage difference adjustment, is provided as-if it covered the outer circumference area of the rotor.

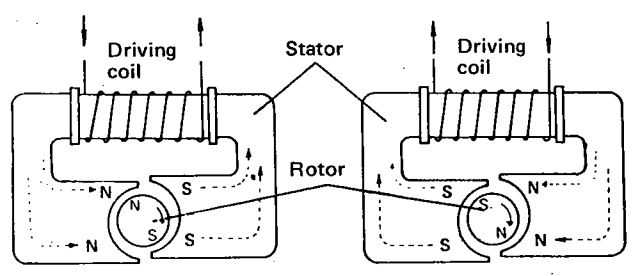
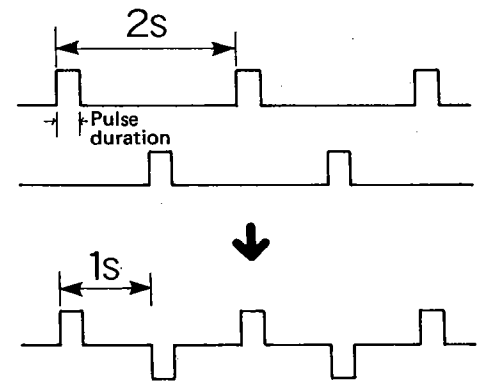

2) Structure of movement

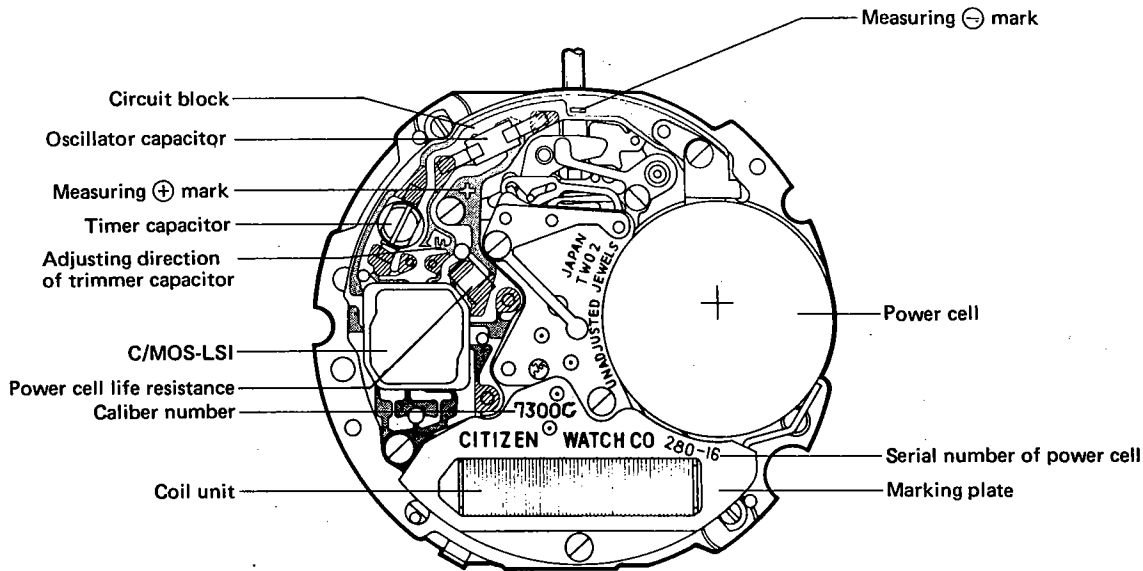

The movement comprises the circuit block, coil unit, power cell, train wheels surrounded by these mentioned parts, and mechanical part consisting mainly of a step motor. To facilitate an easy check and adjustment, such marks are displayed as the adjusting direction of the trimmer capacitor, ⊕ and ⊖ marks for measurement purpose etc.

3) Start/stop and hand setting mechanism

When the crown is pulled out two steps, the reset lever hits the reset terminal. And the division output of the circuit is held to give a power-saving state. At the same time, the second-hand stops instantaneously (second-hand stopping device at an optional position), although the crystal keeps oscillations yet.

In this case, the movement of the fourth wheel 2nd pinion is stopped with the reset lever, and also the train wheels are stopped their movements simultaneously. The hands start again in one second after the crown is pushed in.

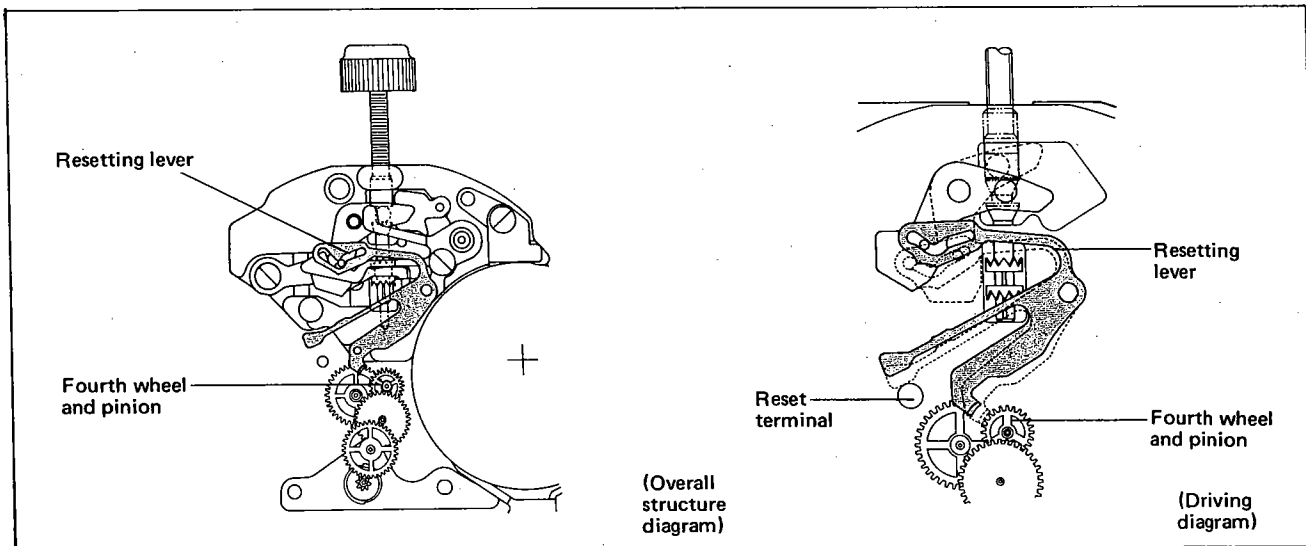

5. SPECIFICATIONS

Caliber Nos.		7300A	7300C	7310A
Type		Analog-type quartz crystal watch (Center second)		
Movement	Size	26.0φmm		
	Thickness	3.82mm		
Oscillation		32,768Hz		
Accuracy (in room temperature)		±15 sec. per month		
Effective temperature range		-10°C ~ +60°C		
Converter		Bipolar step motor		
Integrated circuit		C/MOS-LSI (1 unit)		
Additional mechanisms	Date	○	○	○
	Day	○	○	×
	Bilingual day display	○	○	×
	Date quick setting	○	○	○
	Day quick setting	○	○	×
	Second-hand stopping	○	○	○
	Power-saving switch	○	○	○
	Power cell life warning	×	○	○
	Second setting device	×	×	×
Power cell	Parts Nos.	280-16	←	←
	Voltage	1.5V	←	←
	Capacity	100mAH	←	←
	Size	11.6φ X 4.2mm	←	←
	Life	About 2 years	←	←

6. DISASSEMBLY/ASSEMBLY OF MOVEMENT WITH LUBRICATION

Disassembling sequence: ① → ④⑩ (Figured in diagram)

Assembling sequence: ④⑩ → ①

The number of the screw coming with parts is shown by the symbol like (T1).

The kinds of oil and the areas to be lubricated are shown as follows.

⊖ : Synt-A-Lube oil ⊖ : Synt-V-Lube oil ⊖ : CH-1 oil

1) Dial side

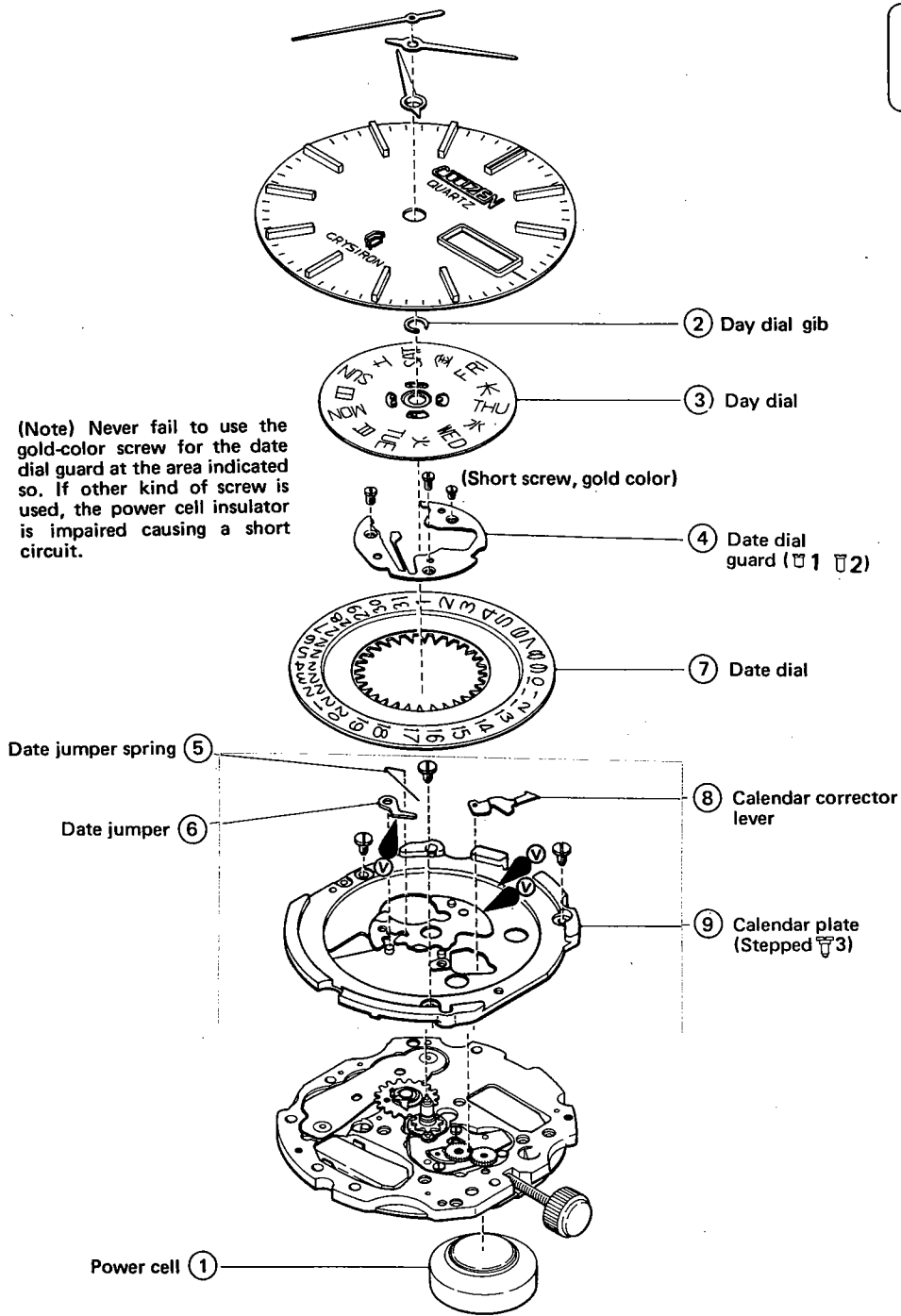

(Note) Never fail to use the gold-color screw for the date dial guard at the area indicated so. If other kind of screw is used, the power cell insulator is impaired causing a short circuit.

Use the movement holder for Cal. No. 71-series watches.

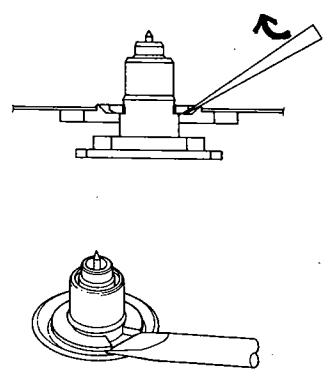

The day dial gib is removed by pry-opening at the groove using a driver, as illustrated above.

2) Bridge side

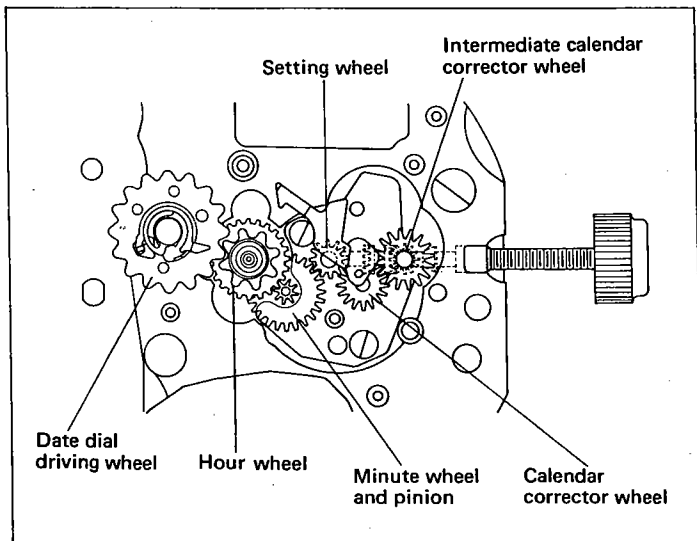

Lubricate the slip area between the gear of the driving wheel and the minute wheel pinion with CH-1 oil.

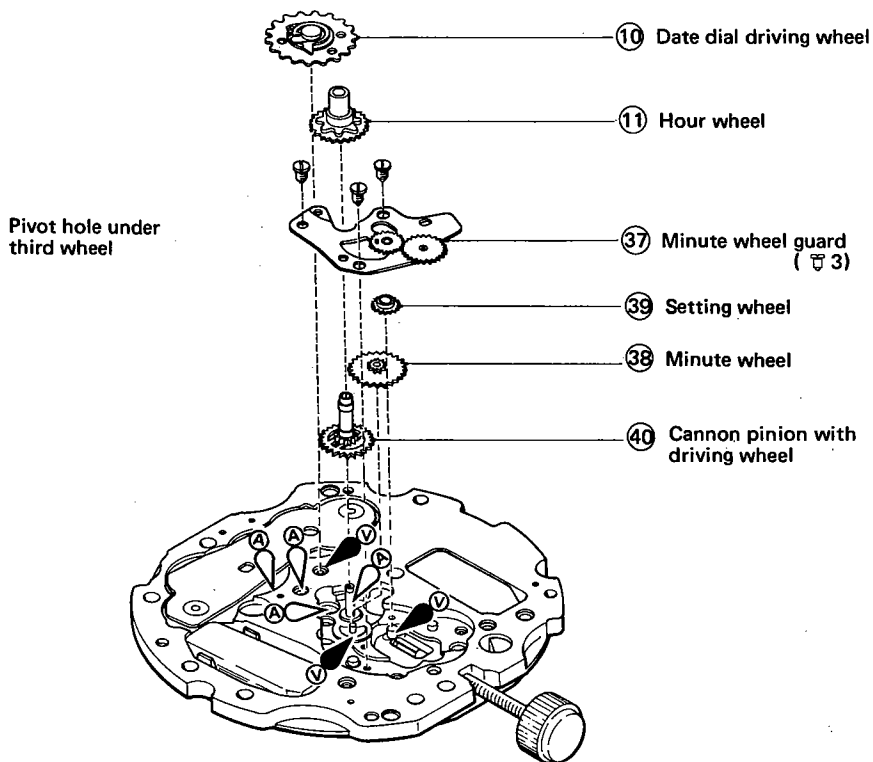
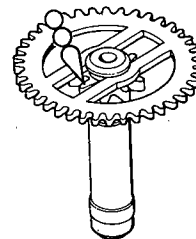

Some minute wheel guards are in the shape as shown below.

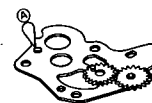

3) Electronic circuit side

The parts in the electronic circuit are not required to wash. However, the dust or stains stuck at the contact areas must be cleared away in order to avoid the deterioration of functions.

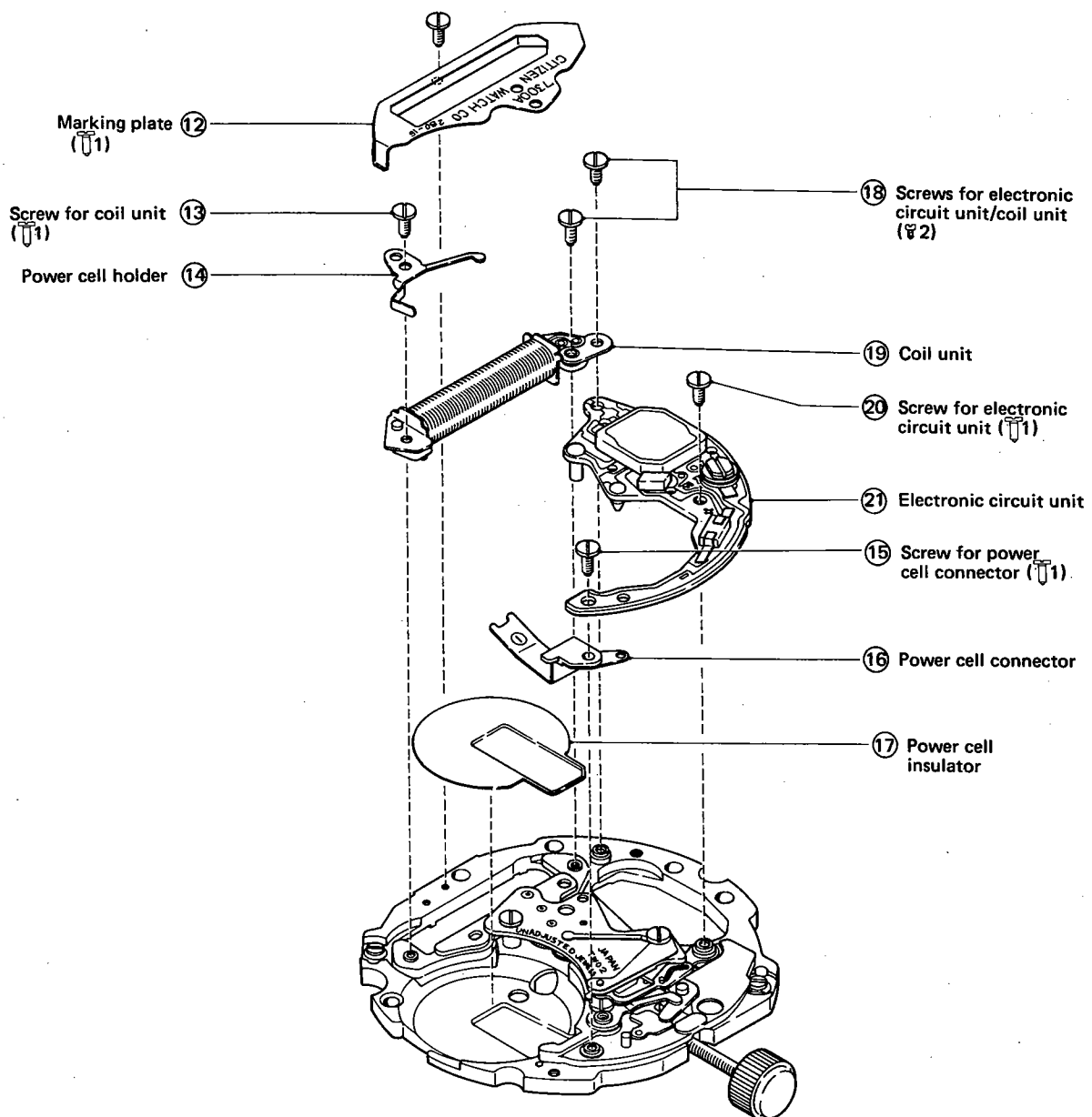

4) Train wheels side

(Note) Make sure the guard spring is holding the fourth wheel and pinion correctly.

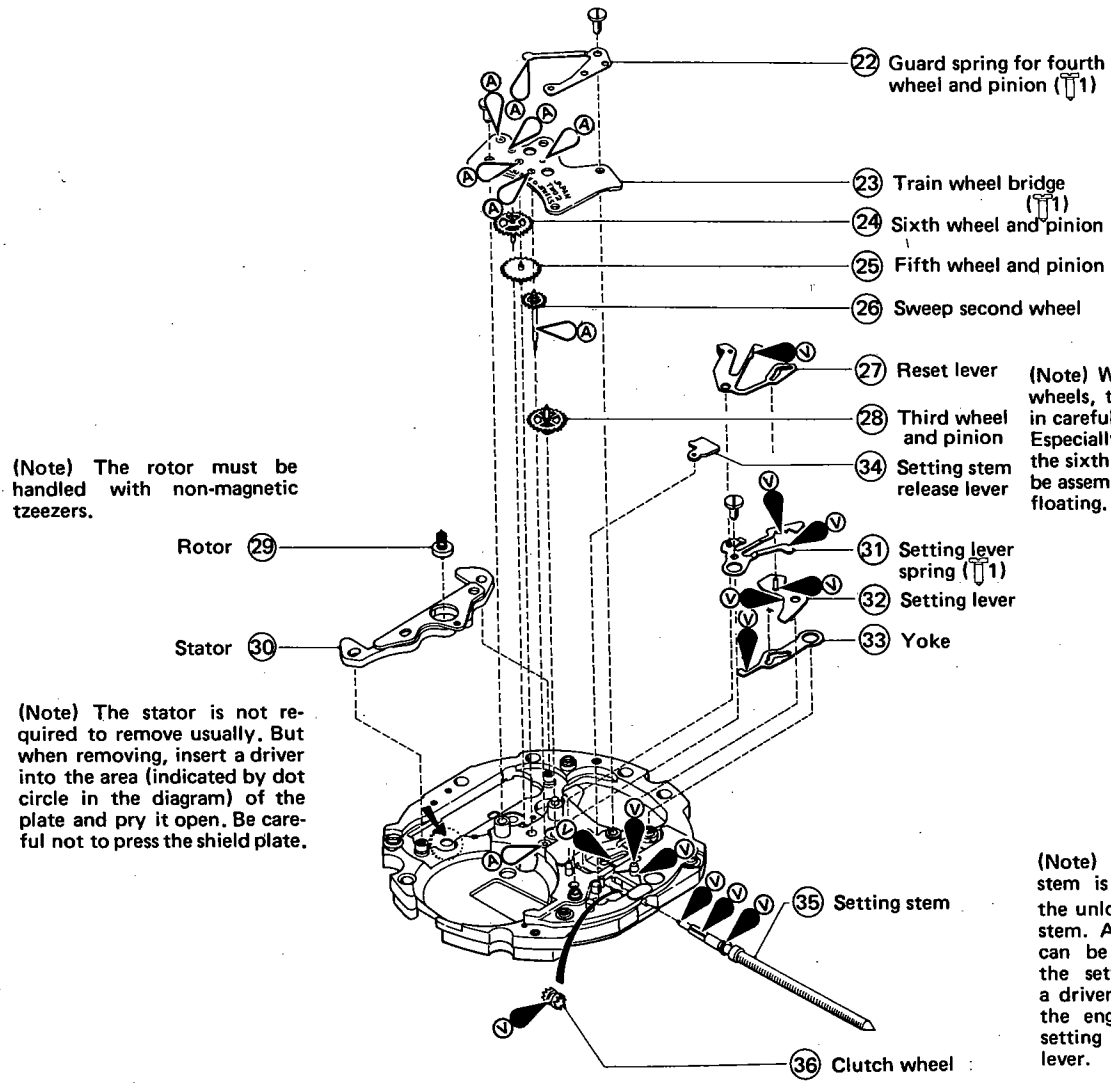

(Note) The rotor must be handled with non-magnetic tweezers.

(Note) The stator is not required to remove usually. But when removing, insert a driver into the area (indicated by dot circle in the diagram) of the plate and pry it open. Be careful not to press the shield plate.

(Note) When assembling train wheels, the pivot must be put in carefully. Especially, the lower pivot of the sixth and third wheels must be assembled correctly with no floating.

(Note) Usually, the setting stem is removed by pressing the unlocking lever for setting stem. Also, the setting stem can be removed by making the setting lever float using a driver or the like to release the engagement between the setting stem and the setting lever.

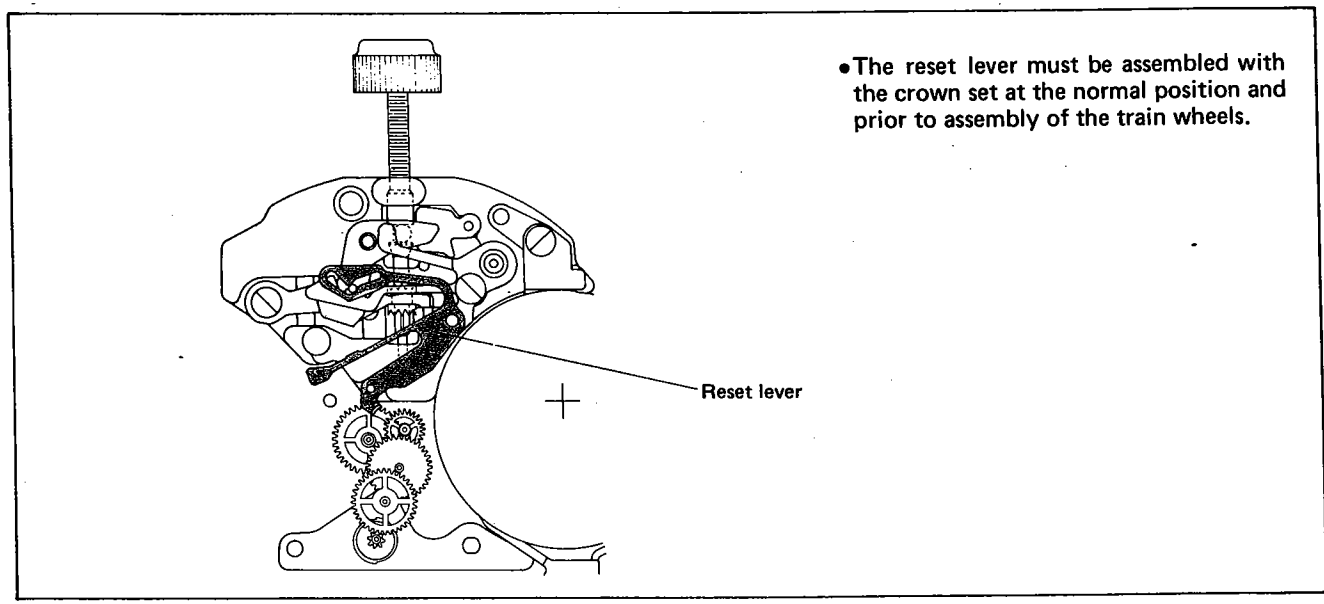

• The reset lever must be assembled with the crown set at the normal position and prior to assembly of the train wheels.

7. TROUBLESHOOTING AND ADJUSTMENT

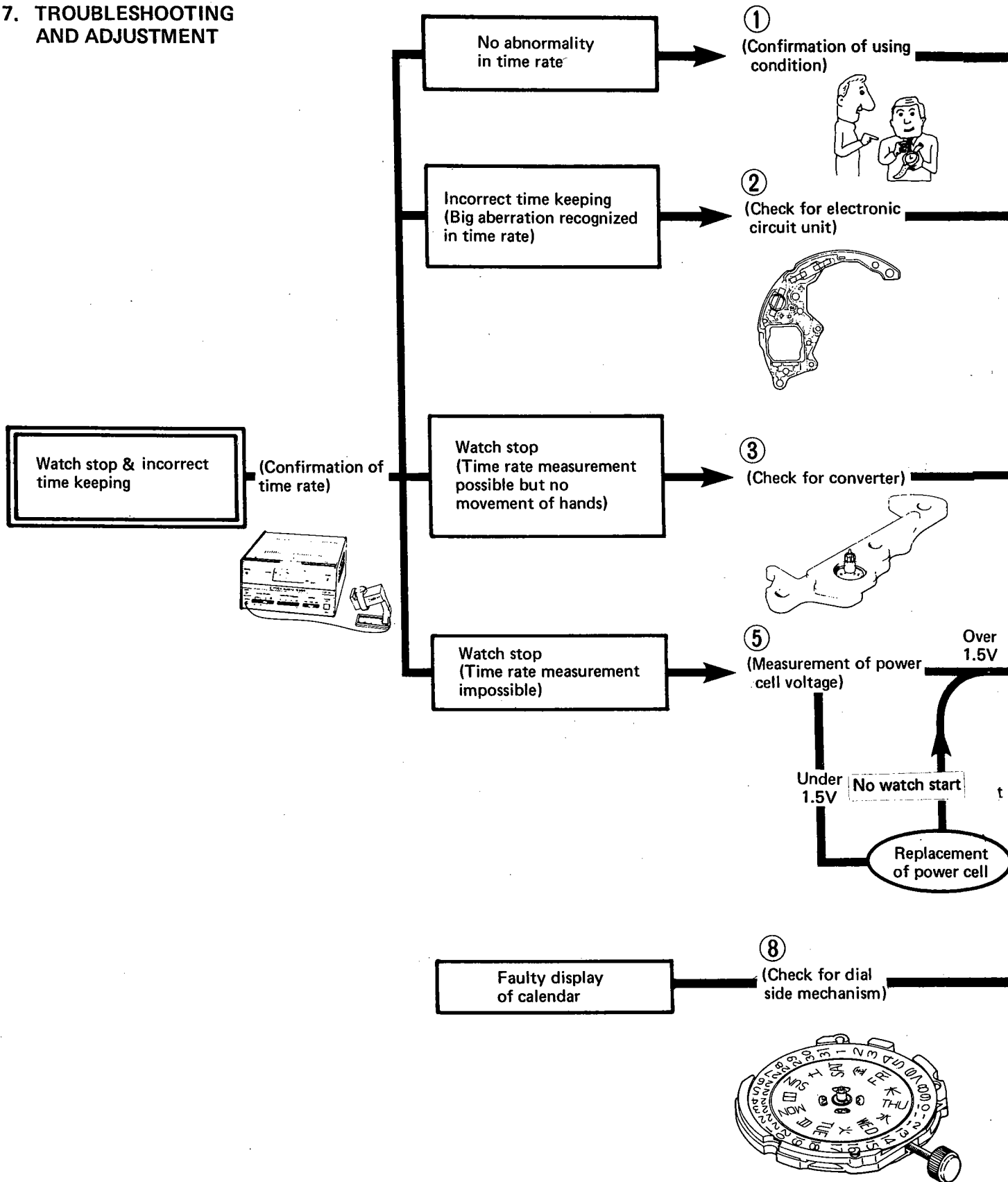

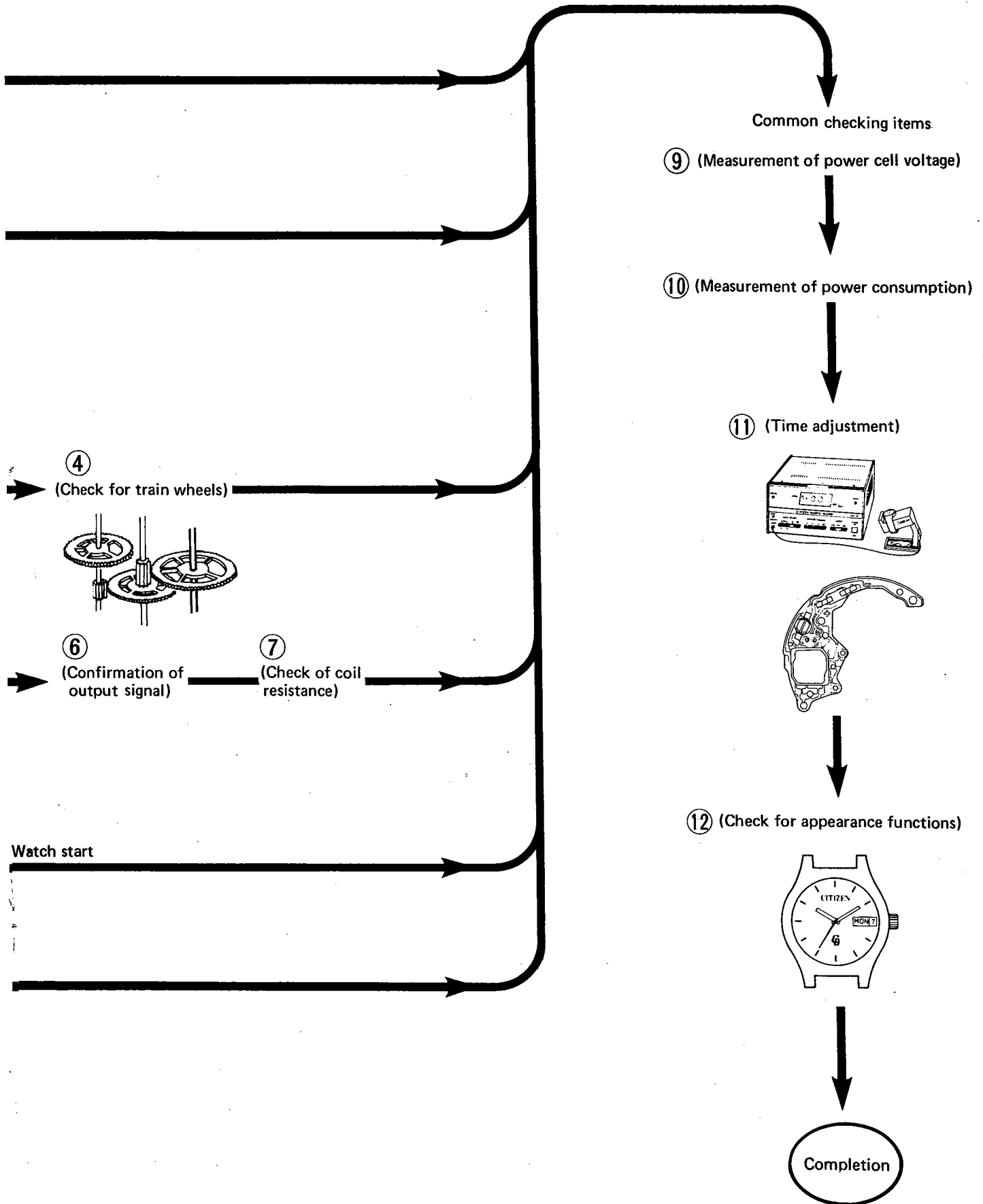

No abnormality in time rate

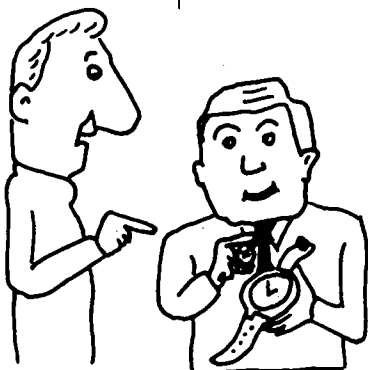
Check items	How to check	Results	Treatment
<p>1 Confirmation of using condition</p>	<p>Confirm how the customer has used the watch.</p> <ul style="list-style-type: none"> •Wasn't there any mistake in handling the watch? 		

Incorrect time keeping (Big aberration recognized in time rate)

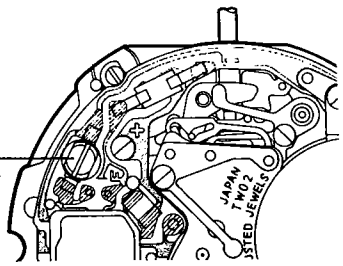
Check items	How to check	Results	Treatment
<p>2 Check for electronic circuit unit</p>	<p>In case the time rate has a big aberration, it is conceivable that the quartz crystal oscillator in the electronic circuit unit has a big aberration in its frequency.</p> <p>So confirm the following points.</p> <ol style="list-style-type: none"> (1) Check whether the time adjustment is possible with operation of the trimmer capacitor. (2) If the time adjustment is impossible with the trimmer capacitor, the quartz crystal oscillator may be faulty. (3) The time adjustment is well possible with the trimmer capacitor.  <p>Trimmer capacitor</p>	<p>→ Replacement of electronic circuit unit</p> <p>→ Common checking items</p>	

Watch stop (Time rate measurement possible but no movement of hands)

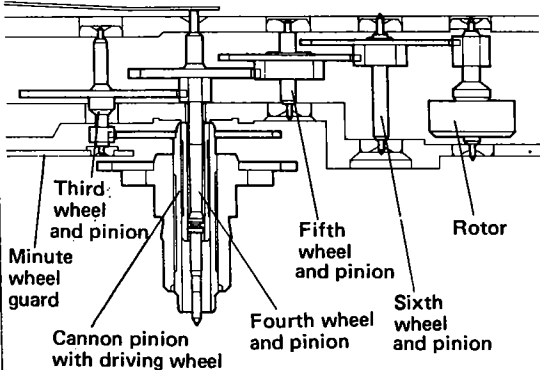
Check items	How to check	Results	Treatment
3 Check for converter	<p>The converter functions to convert the energy of the electrical signal into the mechanical energy. So have a thorough check as follows.</p> <p>Check for rotor mechanism:</p> <ul style="list-style-type: none"> • Is the play of the rotor appropriate? • Isn't there any trouble with the rotor pinion? • Isn't there any iron filings stuck at the upper pivot of the rotor? <p>Check points: If the time rate measurement is possible although the operation is stopped, the electrical system has no trouble. So have a check for the mechanical system — the converter and the train wheels mechanism.</p>		
4 Check for train wheels mechanism	<ol style="list-style-type: none"> 1. The amount of play must be appropriate for the sixth wheel, fifth wheel, fourth wheel, third wheel and cannon pinion with driving wheel respectively. At the same time, the area between the pinion and gears must be free from dust and other alien objects. 2. Check whether each hole jewel has any cracks. 3. Check the lubrication state at each area to be oiled in regard of the oil overflow, lack of oil, oil stains, etc. 		

Common checking items

5 Measurement of power cell voltage

Power cell voltage : 1.5V or more

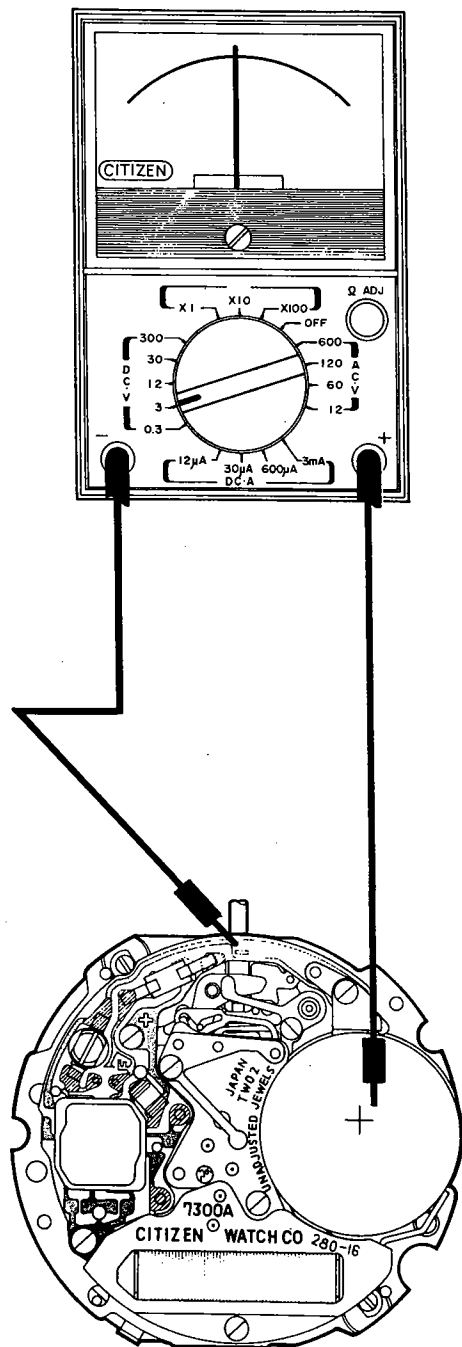

Result and Treatment

1.5V or more

- No operation
→ ⑥ Confirmation of output signal
- Normal operation
→ ⑩ Measurement of power consumption

1.5V or less

- The power cell is replaced:
- No operation
→ ⑥ Confirmation of output signal
 - Operation start
→ ⑩ Measurement of power consumption

Note

In case the watch has been used more than five years, the power cell must be replaced with new one even though the power cell shows more than 1.5V output.

How to Put in Power Cell

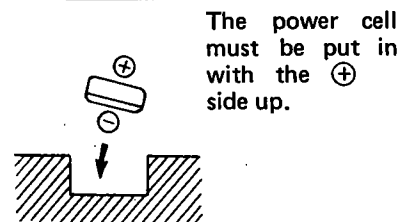

6 Confirmation
of output
signal

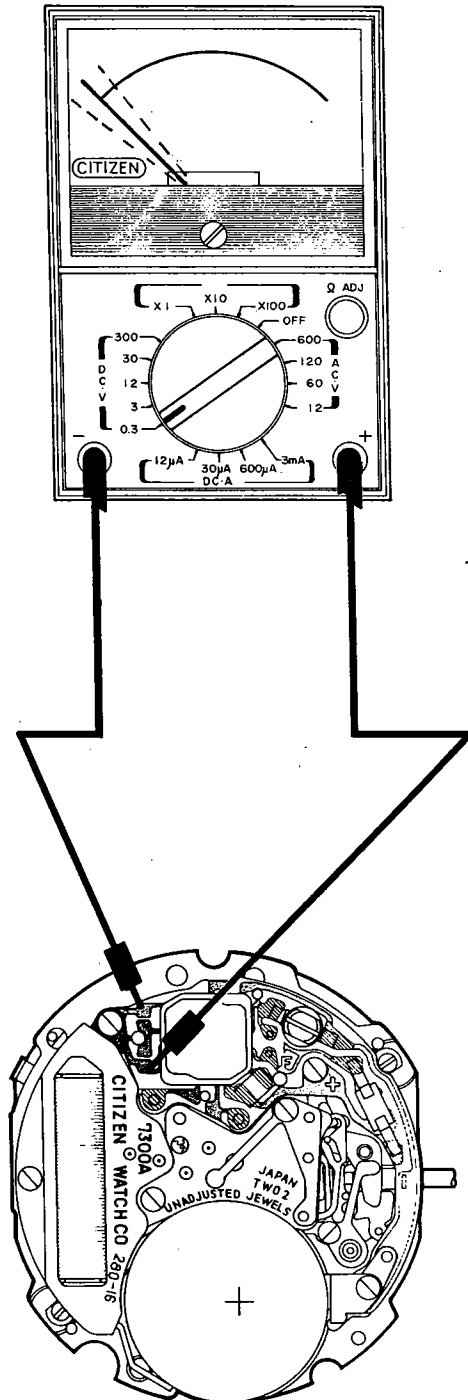

Result and Treatment

- The crown is set at the normal position.
- If the meter index swings right and left centering on 0V with every second. It is known that the output signal is delivered correctly.

Output signal OK

→ ⑦ Check for coil resistance

No output signal

→ Replacement of electronic circuit unit

Caution

Either of the \oplus and \ominus test leads can be applied to either terminals of they watch movement.

7 Check for coil resistance

Coil resistance: $1.6K\Omega \sim 2.4K\Omega$

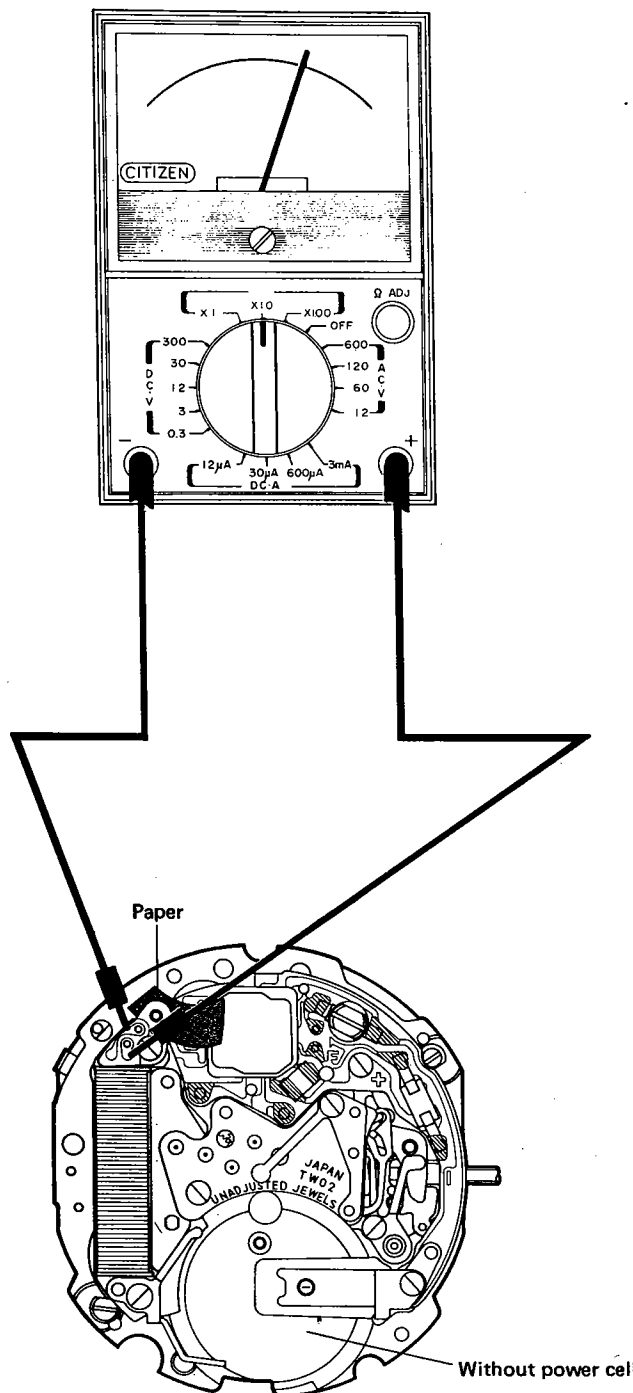

Result and Treatment

The coil resistance is:

Within $1.6K\Omega \sim 2.4K\Omega$

→ Common checking items

Outside $1.6K\Omega \sim 2.4K\Omega$

→ Replacement of coil unit

Cautions

- 1) Never fail to perform 0Ω -adjustment prior to measurement by giving a short circuit to both terminals of the tester.
- 2) The screws for marking plate, power cell and electronic circuit unit are removed, and the screw for the coil unit is un-tightened. Then an insulation is secured between the coil unit and the electronic circuit by inserting a piece of paper, etc. between them. After this, the coil resistance is measured.
- 3) Either of the \oplus and \ominus test leads can be applied to either terminals of the watch movement.

Check items	How to check	Results	Treatment
<p>8 Check for dial side mechanism</p>	<p>Check the calendar mechanism as follows.</p> <p>1. Turn the hands, and check whether both the day and date change correctly.</p> <p>A. No movement of date dial</p> <ul style="list-style-type: none"> • Check whether the date jumper is out of position. • Check whether the date driving click of the date dial driving wheel has any deformation. • Check whether the date dial has any deformation such as warp, creak, etc. <p>B. No movement of day dial</p> <ul style="list-style-type: none"> • Check whether the day driving click of the date dial driving wheel has any deformation. <p>2. Check whether the day and date can be set quickly with the crown pulled out one step.</p> <ul style="list-style-type: none"> • Check whether the calendar corrector lever is out of position. • Check whether too much amount of oil is supplied to the calendar corrector wheel. • Check whether a sufficient amount of oil is supplied to the rubbing surface of the date dial of the calendar plate. 	<p>Date jumper out of position →</p> <p>Click deformed →</p> <p>Click deformed →</p> <p>Lever out of position →</p> <p>Too much oil supplied →</p> <p>Insufficient oil supply →</p>	<p>Reassembly</p> <p>Replacement of date dial driving wheel</p> <p>Replacement of date dial driving wheel</p> <p>Reassembly</p> <p>Cleansing</p> <p>Lubrication</p>

9 Measurement of power cell voltage

Power cell voltage: 1.5V or more

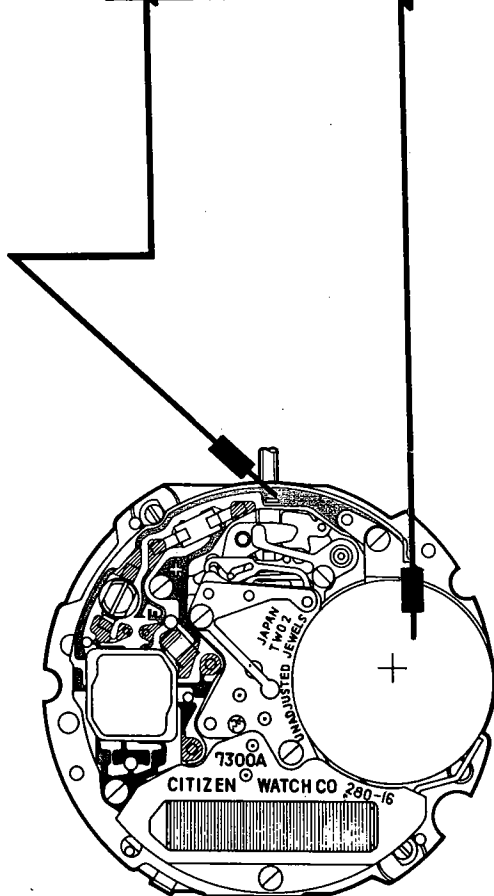
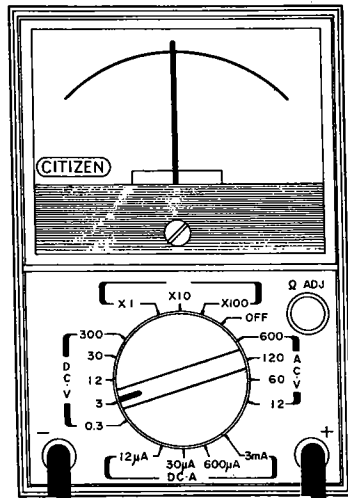

Result and Treatment

1.5V or more

- No operation
→ ⑥ Confirmation of output signal
- Normal operation
→ ⑩ Measurement of power consumption

1.5V or less

The power cell is replaced:

- No operation
→ ⑥ Confirmation of output signal
- Operation start
→ ⑩ Measurement of power consumption

Note

In case the watch has been used more than five years, the power cell must be replaced with new one even though the power cell shows more than 1.5V output.

How to Put in Power Cell

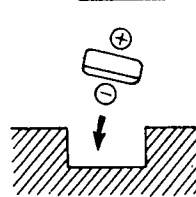

The power cell must be put in with the + side up.

10 Measurement of power consumption

Power consumption: $4.0\mu\text{A}$ or less

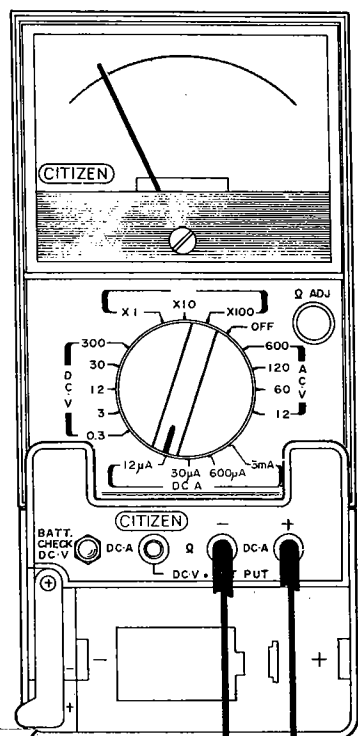

Power cell

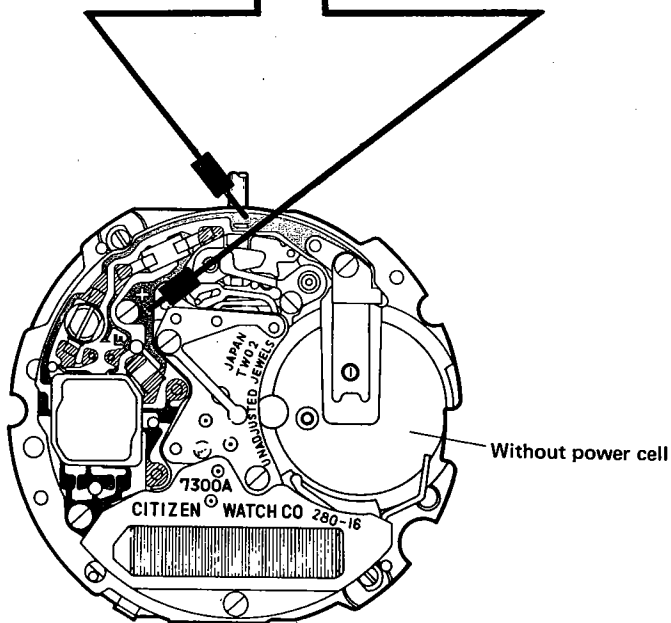

Result and Treatment

- 1) Power consumption readings in normal state:

$4.0\mu\text{A}$ or less

→ ① Time adjustment

$4.0\mu\text{A}$ or more

→ ② Measurement of power consumption at power-saving state

- 2) Measurement of power consumption at power-saving state (crown set at time setting position)

$2.0\mu\text{A}$ or less

→ ③ Check for converter

$2.0\mu\text{A}$ or more

→ Replacement of electronic circuit unit

Note

Never fail to put a power cell of 1.5V or more into the power cell holder of the adaptor.

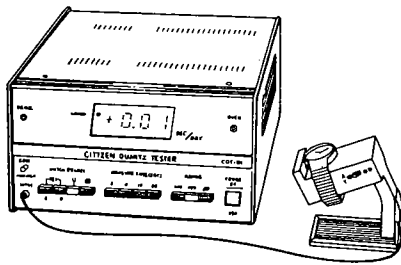
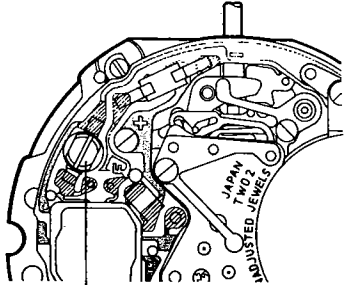
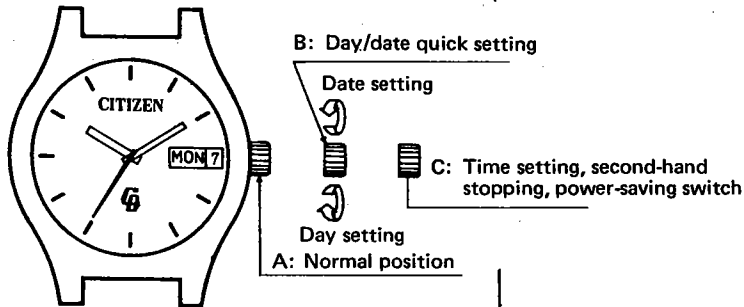
Check items	How to check	Results	Treatment
<p>11 Time adjustment</p>	<p>Measure the time rate using a timing machine.</p>  <p>The time adjustment is carried out in the following procedure.</p> <ul style="list-style-type: none"> •The time can be adjusted by turning right or left the screw of the trimmer capacitor, as illustrated below.  <p>Trimmer capacitor</p>		
<p>12 Check for appearance functions</p>	<p>Check the appearance functions as follows.</p> <ul style="list-style-type: none"> •Make sure that the hand turning is smooth. •Make sure that no abnormality is caused for operation of the time setting, second-hand stopping and power-saving switch, with the crown pulled out two steps (C-position). •Make sure that the quick setting can be carried out properly for the day and date, with the crown pulled out one step (B-position).  <p>(The explanation of the drawing is of 7300A)</p>		

CITIZEN WATCH CO., LTD.
Tokyo, Japan