

TECHNICAL INFORMATION

CITIZEN QUARTZ

Cal. No. 403※※

Cal. No. 402※※

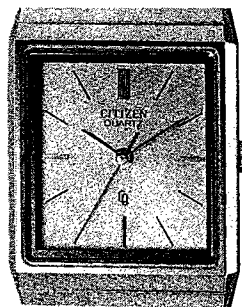

 **CITIZEN**

51. OUTLINE

These Cal. Nos. were developed from Cal. 4A30A which has already received a good response on the market.

By narrowing the hand-spacing of Cal. 4A30A and creating a two-handed model, variations have become rich thus improving marketability.

52. SPECIFICATIONS

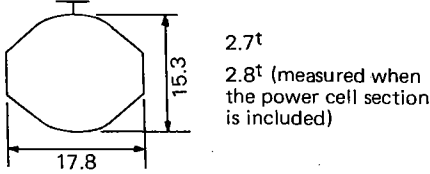
Caliber No.	4031A-00	4A31A-00	4021A-00	4A21A-00	
Type	Analog quartz watch (with a center second hand)	←	Two hands	←	
Module size (mm)		←	←	←	
Accuracy	±30 sec./month at normal temperatures	←	←	←	
Oscillation	32,768Hz	←	←	←	
Integrated circuit	C/MOS-LSI (1 unit)	←	←	←	
Effective temp. range	-5°C ~ +60°C (23°F ~ 140°F)	←	←	←	
Converter	Bipolar step motor	←	←	←	
Adjustment of time rate	Impossible (Attached capacitor)	←	←	←	
Measurement of time rate	2 seconds	←	←	←	
Additional functions	Date (with quick setting device)	X (No)	←	←	
	Day (with quick setting device)	X (No)	←	←	
	Selection of bilingual display of days of the week	X (No)	←	←	
	Second hand stopping device	O (Yes)	←	※	※
	Power saving switch	O (Yes)	←	←	←
	Power cell life indicator	X (No)	←	←	←
Power cell	Parts No.	280-39	←	←	
	Cell code	SR626SW (Ag ₂ O/NaOH)			
	Size	6.8φ x 2.6 ^t (mm)			
	Voltage	1.55V	←	←	
	Capacity	26mAH	←	←	
	Lifetime	About 2 years	←	←	
Current value	Under 1.7μA (Module)	←	←	←	
Value of coil resistance	1.9kΩ ~ 3.5kΩ	←	←	←	
Remarks	* The 2-hands model is provided with a device for stopping the hour and minute hands.				

53. HANDLING INSTRUCTIONS

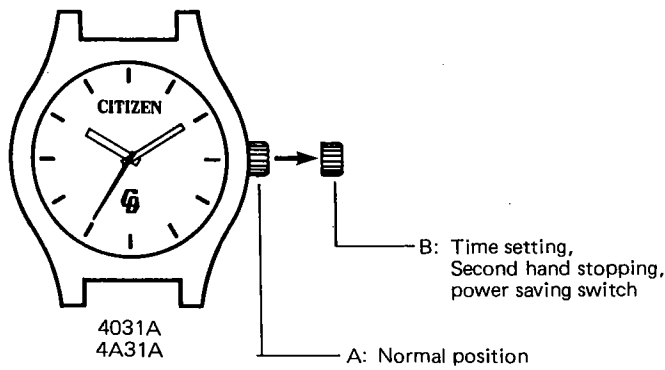

- * Push the crown back into its normal position completely after setting the time.

54. NOTES ON DISASSEMBLY AND ASSEMBLY

Check item	Content
<p>Removing and mounting the setting stem</p>	<div data-bbox="516 892 803 1165" data-label="Image"> <p>Setting stem</p> </div> <ul style="list-style-type: none"> ● Removing the setting stem; Insert the tweezers into the hole on the resetting lever and slide them in the direction of the arrow, as illustrated to the left, and the setting stem will be removed. The above operation should be done with the setting stem remaining in its normal position. ● Mounting the setting stem; The setting stem can be easily mounted by just lightly pushing it in. * Mount the setting stem after the train wheel bridge has been assembled. If it is mounted before the train wheel bridge, the resetting lever will come off, thus making it difficult to assemble the train wheel bridge.
<p>Handling the setting stem</p>	<div data-bbox="548 1396 1117 1486" data-label="Image"> </div> <p>When handling the setting stem, be careful not to damage the portion circled in the illustration or not to get dust or dirt on the setting stem. In particular, when shortening the length of the setting stem, be careful not to damage the circled portion with the four-split tool.</p>
<p>Rotor axis</p>	<div data-bbox="555 1690 776 1864" data-label="Image"> <p>Rotor axis</p> </div> <p>The rotor axis has been pushed into the plate using the sharp tweezers. Carefully handle the rotor axis when disassembling, assembling or cleaning. Completely remove the dust or dirt from the axis.</p>
<p>Spacer for train wheel bridge</p>	<p>The spacer for train wheel bridge can be easily removed by prying it up with the screwdriver.</p>

56. TROUBLESHOOTING AND ADJUSTMENT

Disassembling procedure : ① → ②④
Assembling procedure : ②④ → ①

⊗ A Lube
⊙ V Lube
⊕ F Lube
⊖ CH-1

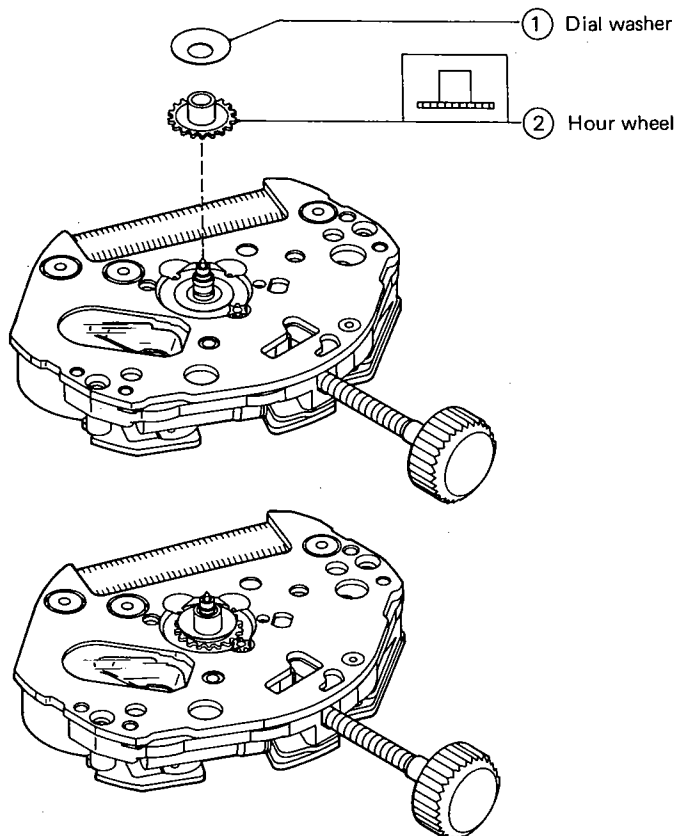

* The movement holder for Cal. 36 *** series can be also used for the listed Cal. Nos.

* The spacer for the train wheel bridge is available in two types. Whichever is used, there will be no problem, and in addition, both may be mounted upside down.

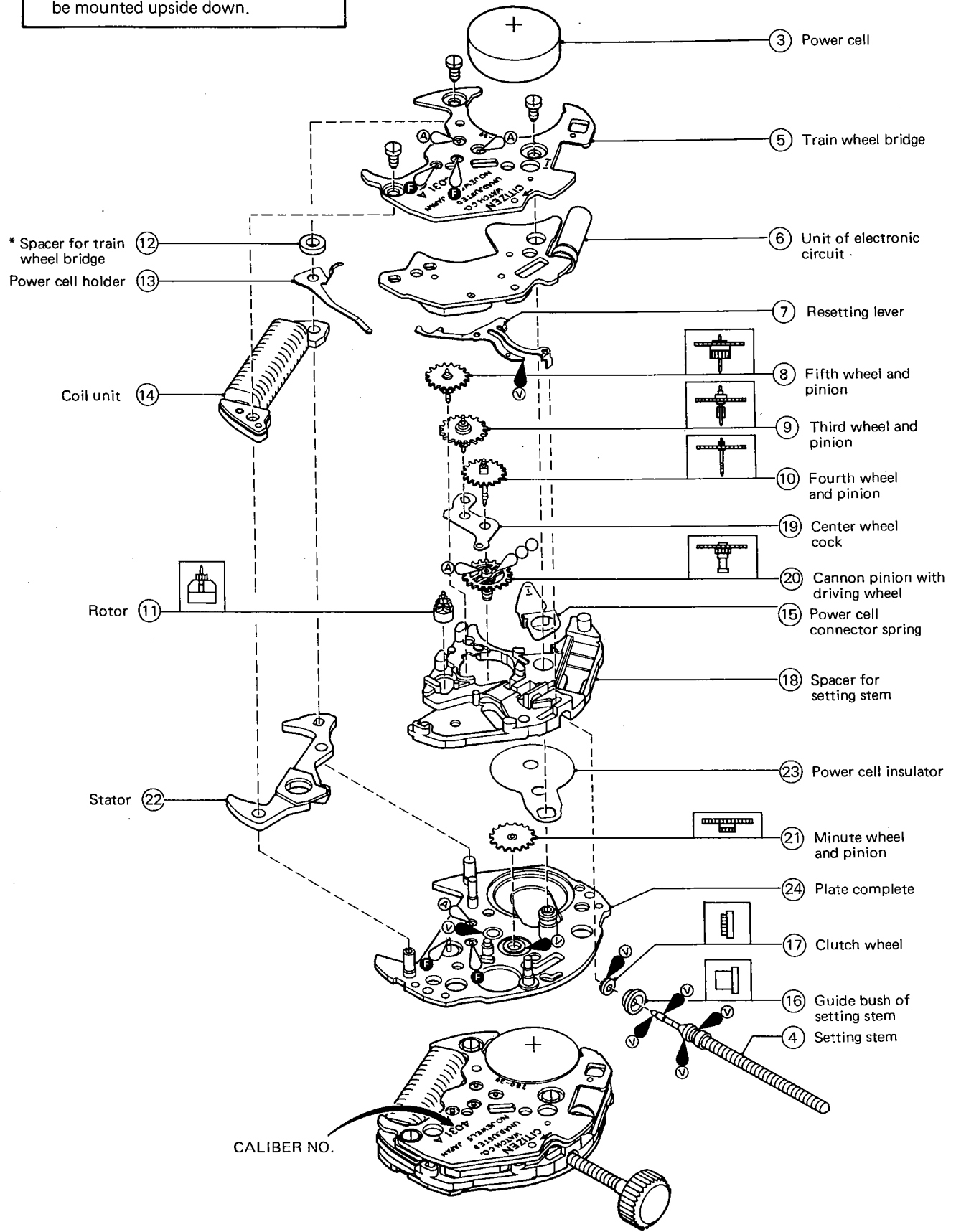
6. Troubleshooting and Adjustment

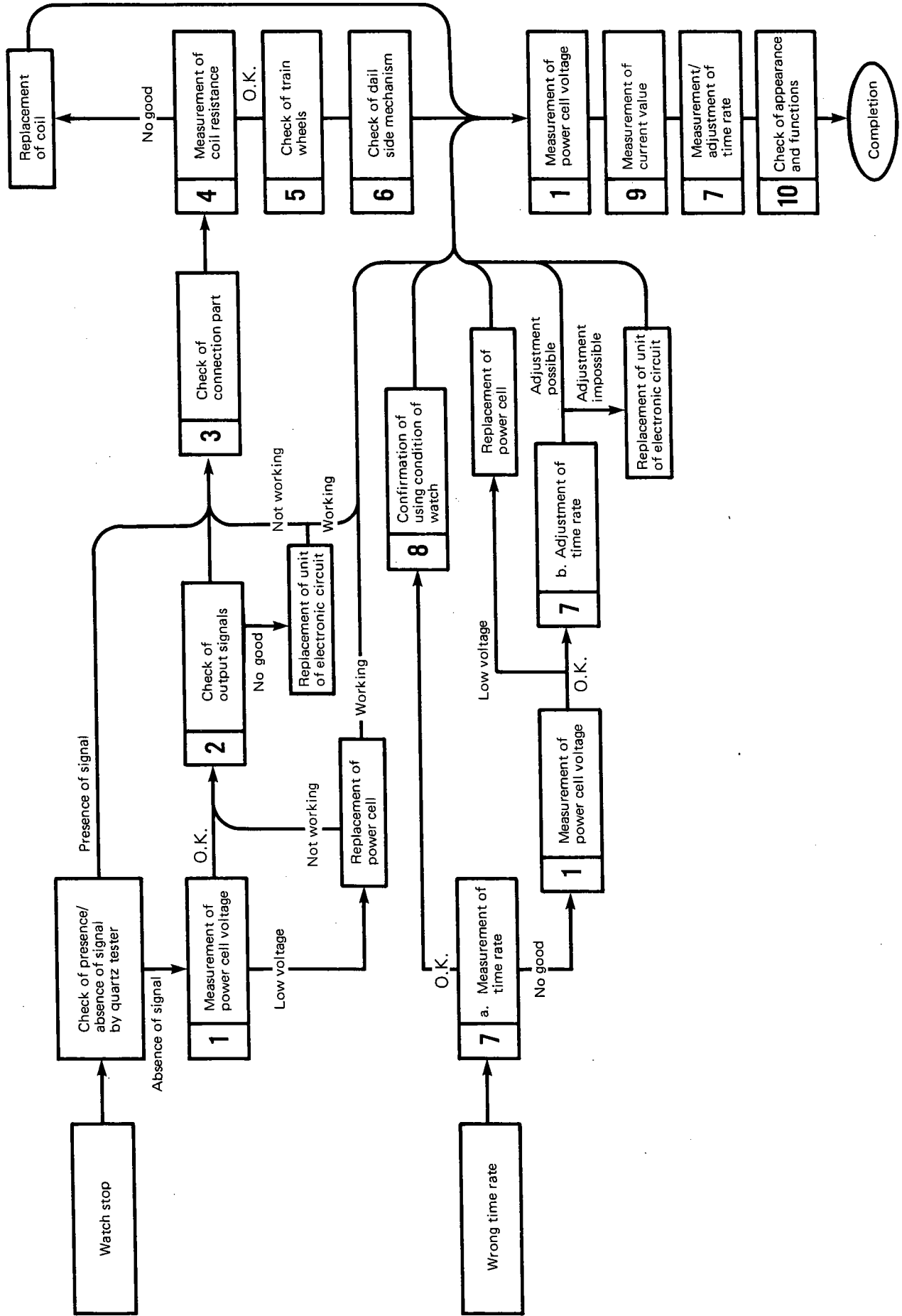

Check item	How to check	Results and treatment
(1) Measurement of power cell voltage	<p>* Refer to the basic manual II-1-a for tester setting.</p> 	<p>Over 1.5V → Nondefective</p> <p>Under 1.5V → Replace the power cell</p>
(2) Check of output signals	<p>* Refer to the basic manual II-1-b for tester setting.</p> 	<p>The tester pointer swings back and forth around "0" every second → Nondefective</p> <p>The tester pointer does not swing → Check the connection parts</p>
(3) Check of connection parts	<p>* Refer to the basic manual II-2-a.</p>	
(4) Measurement of coil resistance	<p>* Refer to the basic manual II-1-c for tester setting.</p> 	<p>1.9kΩ ~ 3.5kΩ → Nondefective</p> <p>Beyond the above range → Replace the coil</p>
(5) Check of train wheel	<p>Refer to the basic manual II-2-b.</p>	
(6) Check of dial side mechanism	<p>Refer to the basic manual II-2-c.</p>	
(7) Adjustment of time rate	<p>Measurement is possible with either of CQT-101 and CQT-210.</p>	<p>There is a big shift in the time rate → Replace the unit of electronic circuit</p>

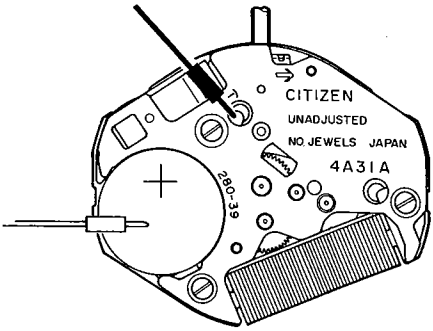
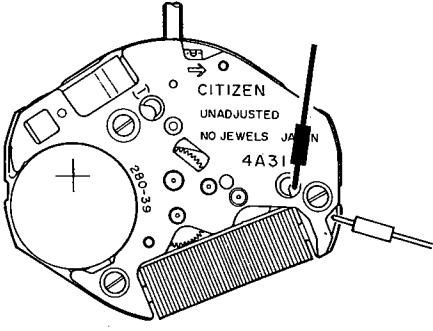
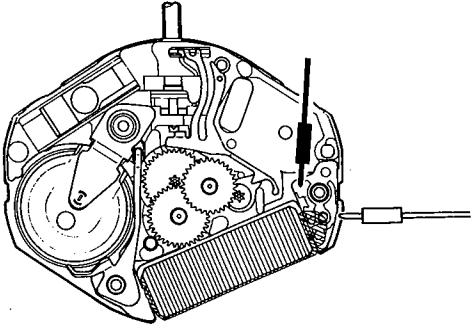
Check item	How to check	Results and treatment
(8) Confirmation using conditions	Refer to the basic manual II-2-e.	
(9) Measurement of current value	<p>* Refer to the basic manual II-1-f for tester setting.</p> 	<ul style="list-style-type: none"> ● Current value of the complete module <ul style="list-style-type: none"> Under $1.7\mu\text{A}$ <ul style="list-style-type: none"> → Nondefective Over $1.7\mu\text{A}$ <ul style="list-style-type: none"> → Measure the unit of electronic circuit singly for current ● Current value of the unit of electronic circuit <ul style="list-style-type: none"> Under $0.6\mu\text{A}$ <ul style="list-style-type: none"> → Nondefective Over $0.6\mu\text{A}$ <ul style="list-style-type: none"> → Replace the unit of electronic circuit
(10) Check of appearance and functions	Refer to the basic manual II-2-5.	

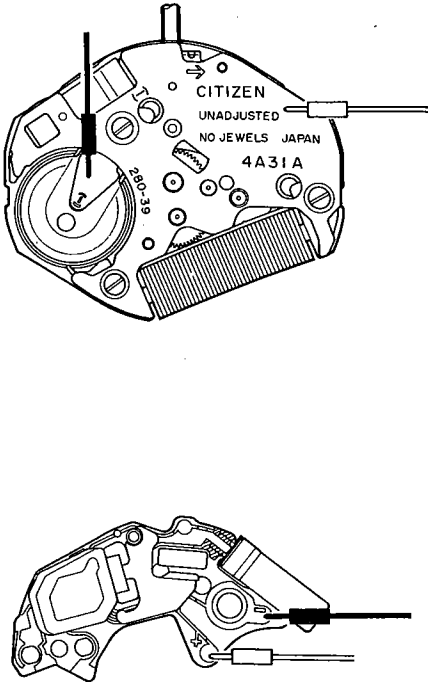
CITIZEN WATCH CO., LTD.

Tokyo, Japan