

***TECHNICAL
INFORMATION***

CITIZEN QUARTZ

Cal. No. 32※※※

 **CITIZEN**

1. OUTLINE

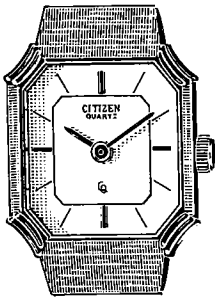

This is an analog quartz watch (with hour and minute hands) for ladies with a reasonable price.

A very compact and thin structure is attained thanks to a reduction of number of component parts as well as the technical development of today.

2. FEATURES

- 1) The lifetime of about 3 years is attained for a power cell.
- 2) The disassembly and assembly is facilitated thanks to a reduction of the number of component parts.
- 3) A variety of designs is possible for the external appearance of the watch owing to a thin structure of the movement.
- 4) A DFC (Digital Frequency Control) system is applied.

3. SPECIFICATIONS

Caliber No.	3220A-02
Type	Analog quartz watch (w/no center second)
Size of movement (mm)	
Oscillation	32,768Hz
Effective temp. range	-10°C ~ +60°C (14°F ~ 140°F)
Converter	Bipolar step motor (20 sec. step movement of hands)
Integrated circuit	C/MOS-LSI (1 unit)
Accuracy	±20 sec./month at normal temp.
Adjustment of time rate	DFC system (w/no control terminal for market use; Unit time of measurement 10 sec.)
Power cell (Silver oxide)	Parts No. : 280-34 (1 unit) Cell code : SR-621SW (Ag ₂ O/NaOH) Nominal voltage: 1.55V Capacity : 15mAH Lifetime : About 3 years Size (mm) : 6.8φ x 2.1 ^t

■4. HANDLING INSTRUCTIONS

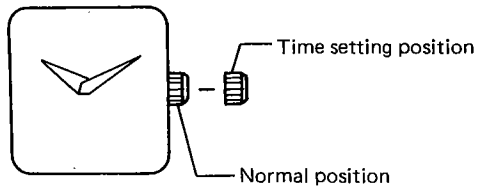

The time is set/corrected by pulling out the crown one step and then turning the crown clockwise and counterclockwise.

After setting the time, push the crown back to its normal position.

This watch lacks a reset mechanism and differs from other watches of this kind having hour and minute hands in terms of the following points.

For the ordinary watches with hour/minute hands and a mechanism of 20-second step movement of hands, the minute hands has an advance equivalent to 20 seconds at a moment when the crown is pushed.

This watch, however, has no reset mechanism and always have an output of the drive signal with every 20 seconds regardless of the operation of the crown.

Some difference will be given to the moment when the second hand starts first according to the crown push timing which is carried out after setting the time. The minute hand will sometimes starts immediately after the push of the crown at the earliest and starts after about 40 seconds at the slowest. (This means the maximum time error of ± 20 seconds compared with other watches of this kind.)

The value of this time error differs according to the crown push timing and within the above-mentioned maximum value. The second hand of this watch will keep a step movement with every 20 seconds after its first movement.

In addition, no brake lever is incorporated into this watch and therefore the train wheels will turn along with the turning of hands. This turn of the train wheels, however, has no inconvenience in terms of the functioning of the watch.

■5. CONSTITUTION OF MOVEMENT

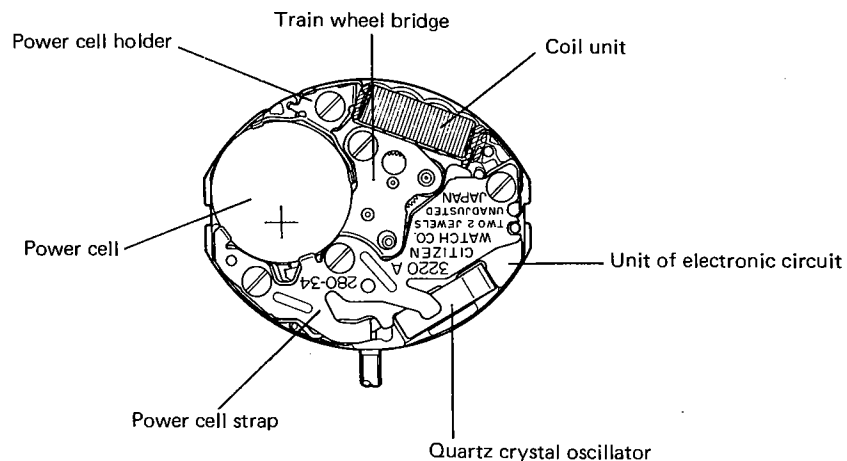

6. DISASSEMBLY/ASSEMBLY OF MOVEMENT WITH LUBRICATION

Disassembling procedure : ① → ②④
 Assembling procedure : ②④ → ①

Marks of lubrication:
 A Synt-A-Lube oil
 V Synta-V-Lube oil
 F Synta-F-Lube oil

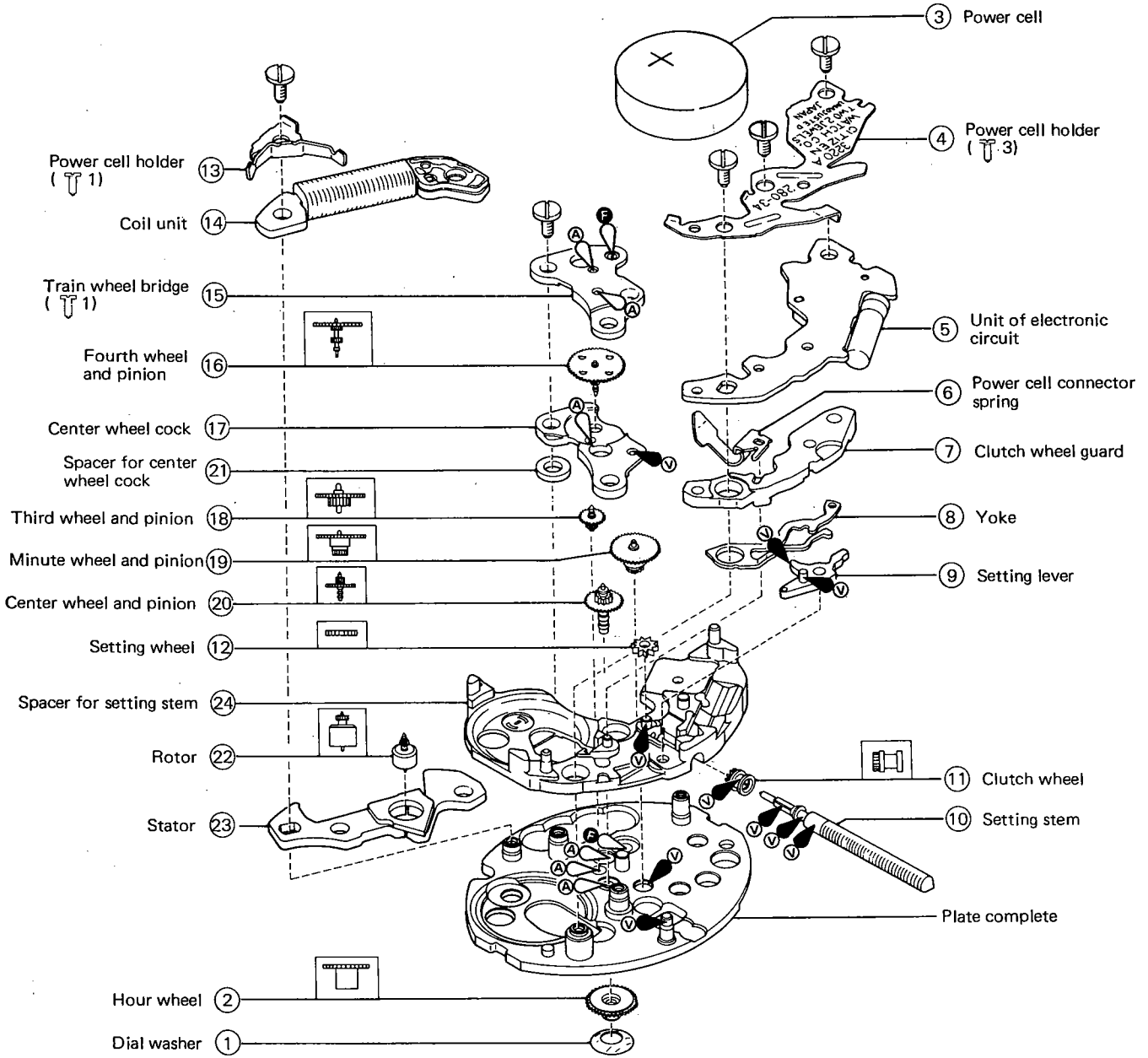

* A movement holder for Cal. No. 3220 is used in common with this caliber.

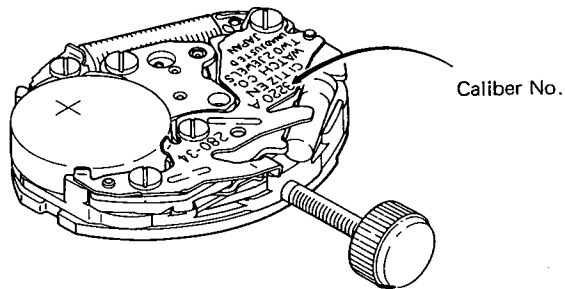

● Notes on Disassembly/Assembly

1) How to remove setting stem

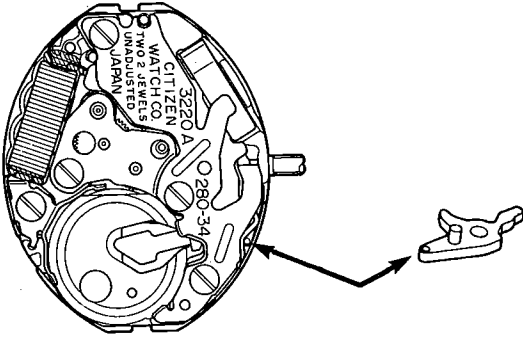

(Fig. 6-1)

The crown is always set at its normal position when the setting stem is removed.

The setting stem is removed by pushing a round recess part of a setting lever as indicated by the arrows in Fig. 6-1.

2) How to unset dial

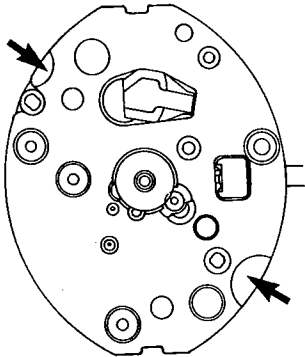

(Fig. 6-2)

The dial is set by a snap-in method and unset by putting a driver or the like into the recess parts (indicated by arrows in Fig. 6-1) of a plate complete and at the areas near the holes into which the dial feet are fitted and then prying the driver outside.

3) Setting of Yoke

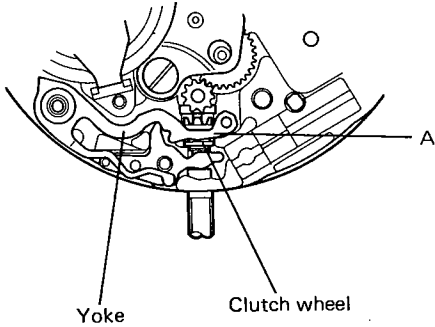

(Fig. 6-3)

The yoke is set as illustrated in Fig. 6-3.

The clutch wheel guard is set after making sure that part A is set completely into the groove of the clutch wheel.

4) Setting of power cell holder

A hook part (indicated by an arrow mark in Fig. 6-4) is put into a hole of the spacer for setting stem, and then a screw for power cell holder is driven.

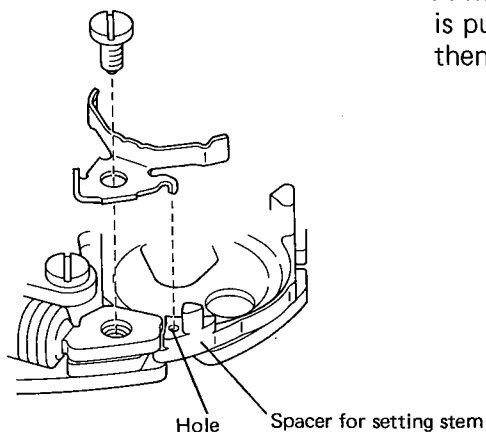

(Fig. 6-4)

5) Setting of hands

Avoid applying the strong force when setting the hands since the thickness of the movement is very small. The movement holder for Cal. No. 3220 is used in common with this caliber.

6) Quick advance of hands

This watch features a 20-second step movement of hands, and it is possible to confirm the movement of hands in a quick advance mode.

As illustrated in Fig. 6-5, a contact is obtained between a quick advance terminal and the plus (+) surface of a power cell strap by means of a tweezers or the like. Thus the hands are advanced by 20 seconds with every second.

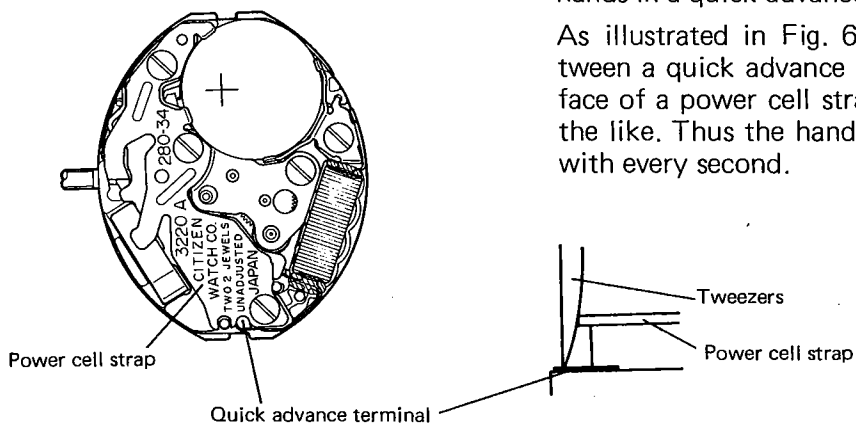

(Fig. 6-5)

17. TROUBLESHOOTING AND ADJUSTMENT

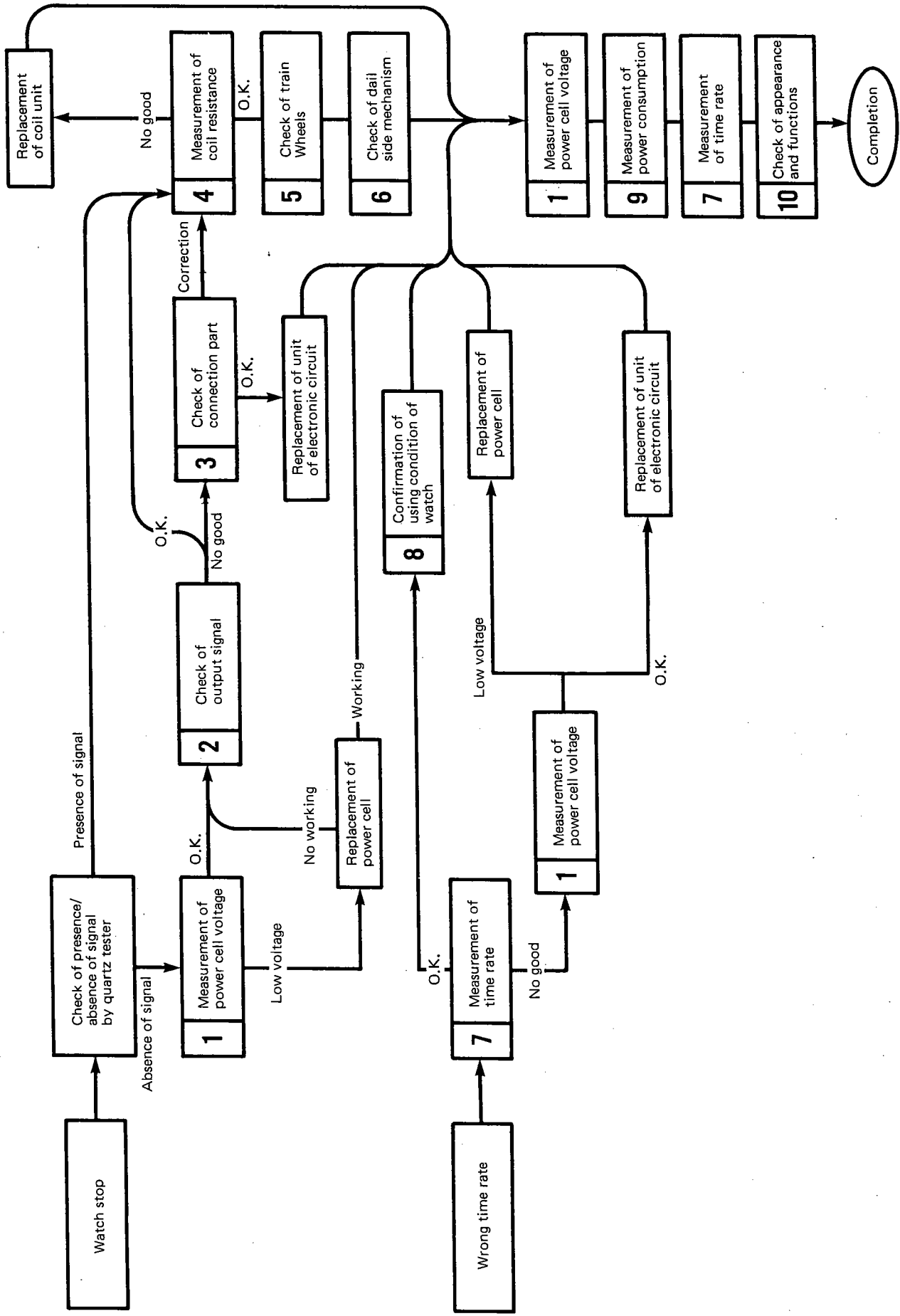

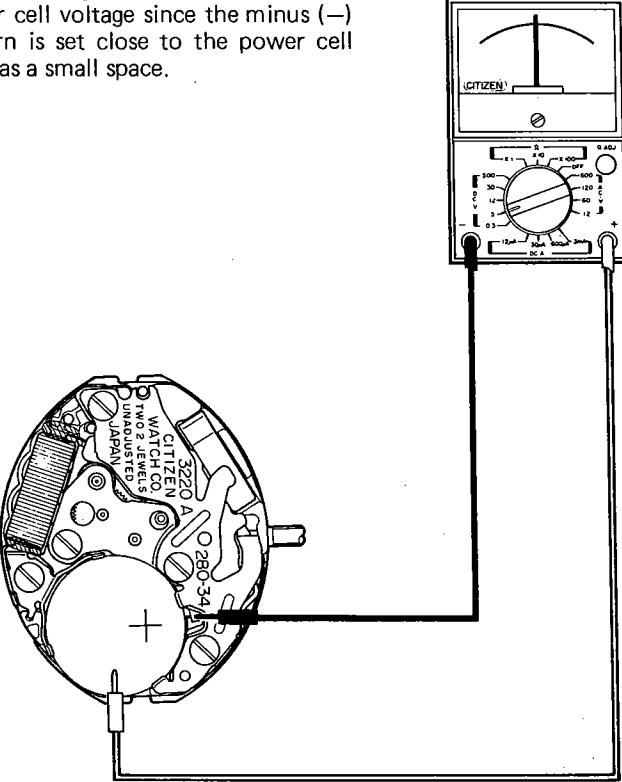
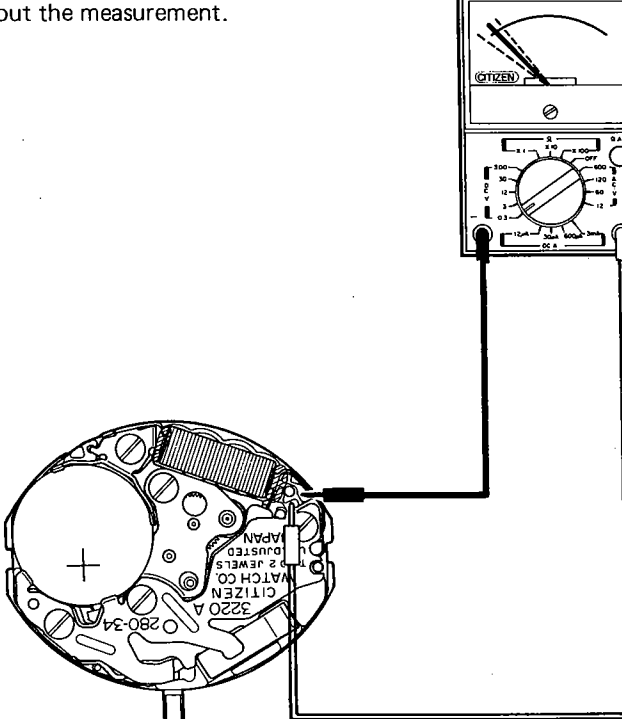
Checking items	How to check	Results and treatment
<p>1 Measurement of power cell voltage</p>	<p>Be careful not to cause a short circuit when carrying out the measurement of power cell voltage since the minus (-) pattern is set close to the power cell and has a small space.</p> <p>(Tester range: DC 3V)</p> 	<p>Over 1.5V → Nondefective</p> <p>Under 1.5V → Replacement of power cell</p>
<p>2 Check of output signal</p>	<p>Make sure that the screws for power cell strap are driven tight before carrying out the measurement.</p> <p>(Tester range: DC 0.3V)</p>  <p>No discrimination required for polarity</p>	<p>Looseness of screw → To be driven tight</p> <p>Tester pointer swinging with every 20 seconds and centering on 0V → Nondefective</p>

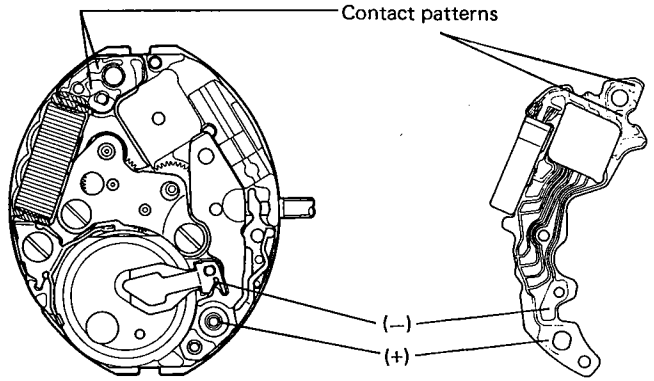
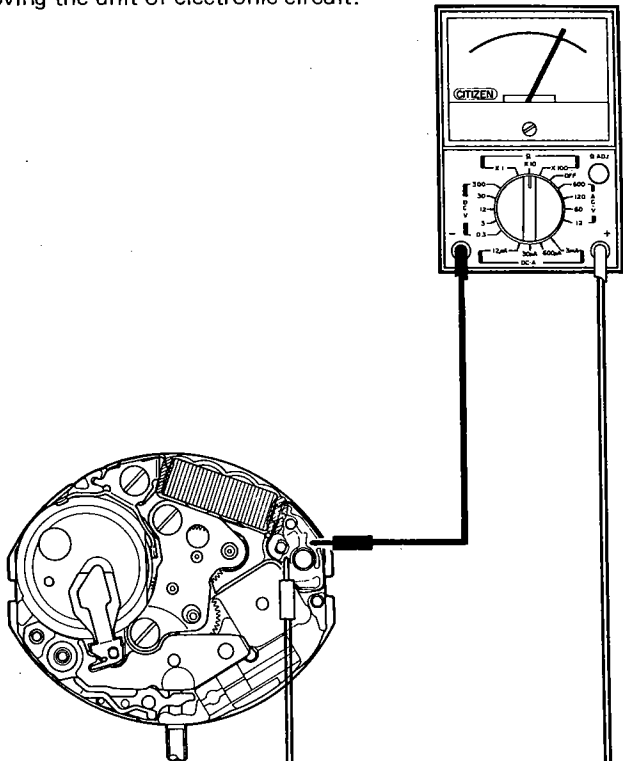
Checking items	How to check	Results and treatment
<p>3 Check of connection part</p>	<p>Make sure that the contact patterns of both a coil unit and a unit of electronic circuit are free from the dust, stains and other foreign matters.</p> <p>Make sure that the plus (+) and minus (-) patterns of the unit of electronic circuit plus the areas of the movement to be connected with these patterns are free from dust, stains and other foreign matters.</p> 	<p>Dust, stains, etc. → To be cleared off</p>
<p>4 Measurement of coil resistance</p>	<p>The measurement is carried out after removing the unit of electronic circuit.</p> <p>(Tester range: X10Ω)</p>  <p>No discrimination required for polarity</p>	<p>1.9 ~ 2.5kΩ → Nondefective</p> <p>Outside 1.9 ~ 2.5kΩ → Replacement of coil unit</p>

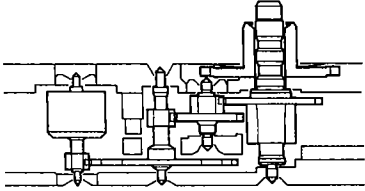
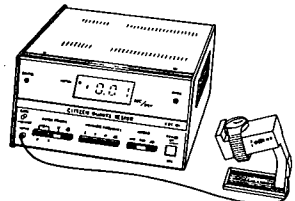
Checking items	How to check	Results and treatment
<p>5 Check of train wheels</p>	<p>The following points are checked.</p> <ol style="list-style-type: none"> 1) The clearance is appropriate for each wheel. 2) The lubrication is good. 3) Each wheel is free from the dust, stains and other foreign-matters. 4) The tenon and the tooth tip of each wheel are free from any malformation and breakage. 	<p>Shortage of oil and sticking of dust and stains → Overhaul with lubrication</p> <p>Malformation or breakage → Replacement of wheels</p>
<p>6 Check of dial-side mechanism</p>	<p>The following points are checked.</p> <ol style="list-style-type: none"> 1) The minute wheel and pinion, setting wheel and hour wheel are free from any malformation and breakage. 2) No defect is detected for the pin (spacer for setting stem) to which the setting wheel is fitted. 3) A proper clearance is secured for the hour wheel after setting the dial. 	<p>Malformation or breakage → Replacement of relevant parts</p> <p>Improper clearance → To be corrected</p>
<p>7 Measurement of time rate</p>	<p>Both CQT-101 and CQT-210 are used to measure the time rate.</p> <p>Owing to the DFC system, the unit time of measurement is set at "10 sec." or at an integer-fold value of 10 seconds.</p> <p>In case the time rate has a big error, the unit of electronic circuit must be replaced with new one.</p> 	
<p>8 Check of using condition of watch</p>	<p>The following points are checked for a watch with its user.</p> <ol style="list-style-type: none"> 1) Make sure whether the watch has been used at an extremely high or low temperature. 2) Make sure whether the watch has received a severe shock. 3) Make sure whether the watch has been affected by the magnetism. 4) How many days have passed since the watch received the final adjustment of time rate? 	

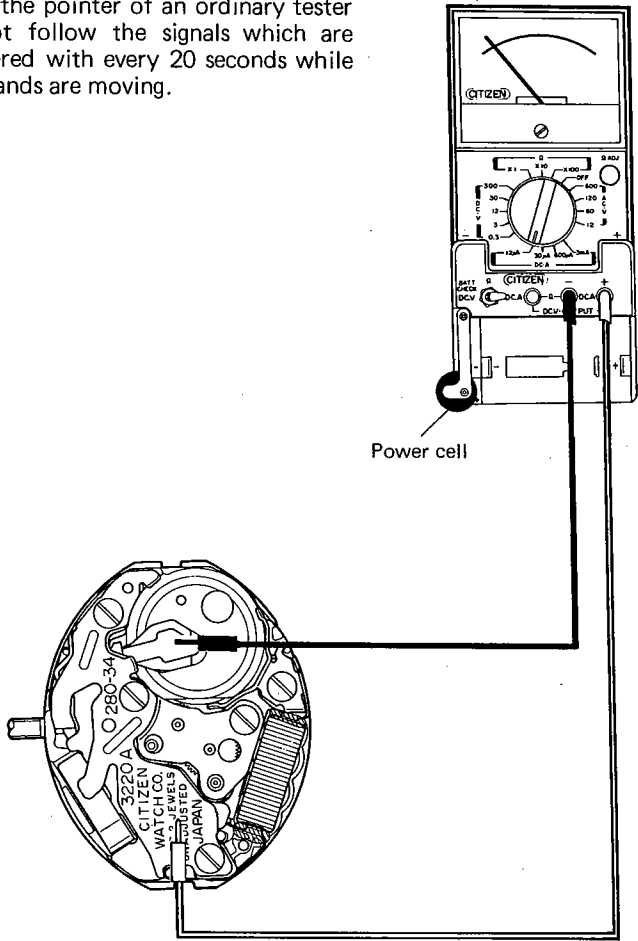
Checking items	How to check	Results and treatment
<p>9</p>	<p>The power consumption is measured while the hands have no movement since the pointer of an ordinary tester cannot follow the signals which are delivered with every 20 seconds while the hands are moving.</p> <p>(Tester range: DC 12μA or 30μA)</p>  <p>Power cell</p> <div style="border: 1px solid black; padding: 5px; margin-top: 20px;"> <p>The value of power consumption may increase if the measurement is carried out in the light of an incandescent lamp or in the sunlight.</p> <p>The light of a fluorescent lamp does not affect the measurement.</p> </div>	<p>Under 0.5μA</p> <p>→ Nondefective</p> <p>Over 0.5μA</p> <p>→ Replacement of unit of electronic circuit</p>
<p>10 Check of appearance and functions</p>	<p>Make sure that the surfaces of the dial and glass are free from the dust, stains and other foreign matters and that the hands can be turned smoothly.</p>	

CITIZEN WATCH CO., LTD.
Tokyo, Japan